

CBSE Class-12 Physics Quick Revision Notes
Chapter-15: Communication Systems

- **Elements of Communication:**

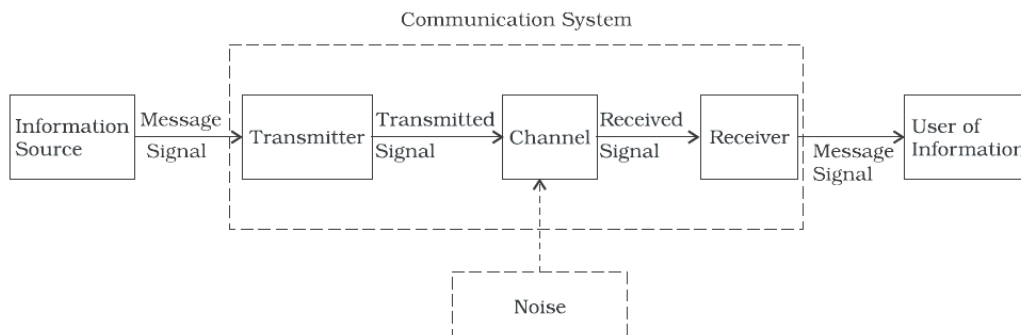

- **Two Basic Modes of Communication:**

- a) Point to point
- b) Broadcast

- **Point to Point Mode of Communication:**

Here, communication takes place over a link between a single transmitter and a receiver. Telephony is an example of such a mode of communication.

- **Broadcast Mode of Communication:**

Here, there are a large number of receivers corresponding to a single transmitter. Radio and television are examples of broadcast mode of communication.

- **Analog Mode of Transmission:**

An analog message is physical quantity that varies with time usually in a smooth and continuous fashion.

- **Digital Mode of Transmission:**

A digital message is an ordered sequence of symbols selected from a finite set of discrete elements.

- **Operational advantages of digital communication system over analog communication systems:**

1. An improved security message.
2. Increased immunity to noise and external interference.
3. A common format for encoding different kinds of message signals for the purpose of transmission.
4. Flexibility in configuration digital communication system.

- **Basic Terminology used in Electronic Communication Systems:**

Transducer, signal, noise, transmitter, receiver, attenuation, amplification, range, bandwidth, modulation, demodulation, repeater

- **Undesirable Effects in the Source of Signal Transmission:**

Attenuation, distortion, interference and noise are the undesirable effects in the source of signal transmission.

- **Bandwidth of Signals:**

- a) The speech signal requires a bandwidth of 2800 Hz (3100 Hz – 300 Hz) for commercial telephonic communication.
- b) For frequencies produced by musical instruments, the audible range of frequencies extends from 20 Hz to 20 kHz.
- c) Video signals for transmission of pictures require about 4.2 MHz of bandwidth.
- d) A TV signal contains both voice and picture and is usually allocated 6 MHz of bandwidth for transmission.

- **Bandwidth of Transmission Medium:**

The commonly used transmission media are wire, free space and fiber optic cable.

- **Propagation of Electromagnetic Waves:**

For transmission over long distances, signals are radiated into space using devices called antennas. The radiated signals propagate as electromagnetic waves and the mode of propagation is influenced by the presence of the earth and its atmosphere. Near the surface of the earth, electromagnetic waves propagate as surface waves. Surface wave propagation is useful up to a few MHz frequencies. Long distance communication between two points on the earth is achieved through reflection of electromagnetic waves by ionosphere. Such waves are called sky waves. Sky wave propagation takes place up to frequency of about 30 MHz. Above this frequency, electromagnetic waves essentially propagate as space waves. Space waves are used for line-of-sight communication and satellite communication.

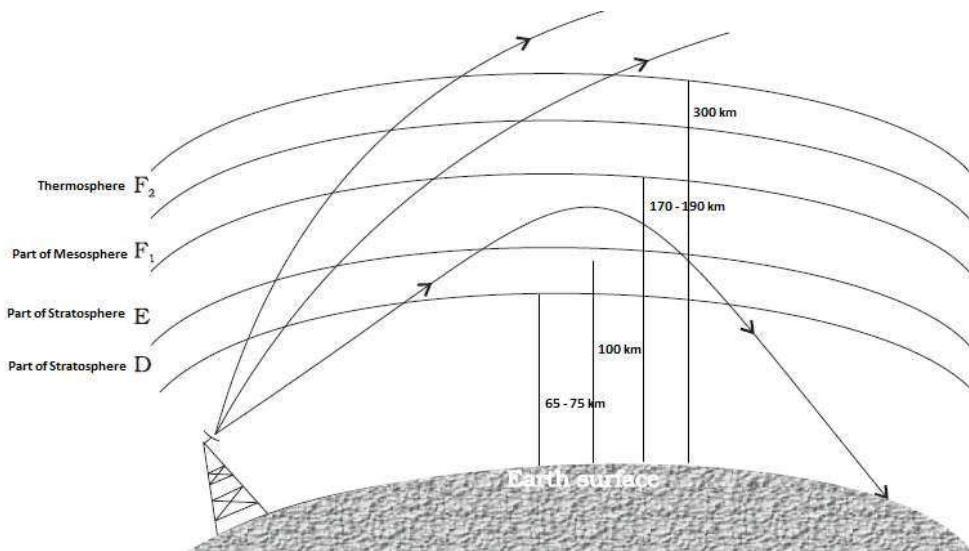

- **Radio Wave Propagation is by Space Waves:**

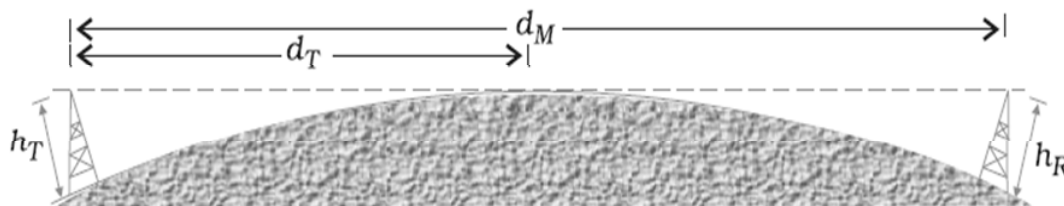

- **Modulation:**

The process of changing some characteristic such as amplitude, frequency or phase of a carrier wave in accordance with the intensity of the signal is known as modulation.

- **Types of Modulation:**

- a) Amplitude modulation
- b) Frequency modulation
- c) Phase modulation.

- **Amplitude Modulation:**

The amplitude of the carrier wave changes according to the intensity of the signal. The amplitude variation of the carrier wave is at the signal frequency f_s .

- **Production of Amplitude Modulated Wave:**

Amplitude modulated waves can be produced by application of the message signal and the carrier wave to a non-linear device, followed by a band pass filter.

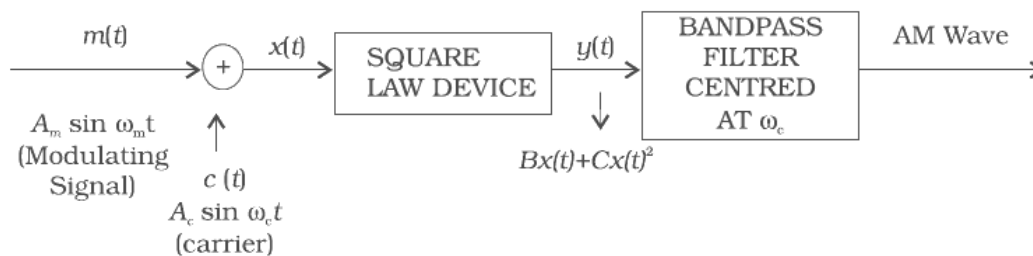

- **Modulation Factor:**

The ratio of change of amplitude of carrier wave to the amplitude of normal carrier wave is called modulation factor (m).

- **Classification of Pulse Modulation:**

Pulse modulation could be classified as: Pulse Amplitude Modulation (PAM), Pulse Duration Modulation (PDM) or Pulse Width Modulation (PWM) and Pulse Position Modulation (PPM).

- **Demodulation:**

Demodulation is the process of recovering the signal intelligence from a modulated carrier wave.

- **Transmitter:**

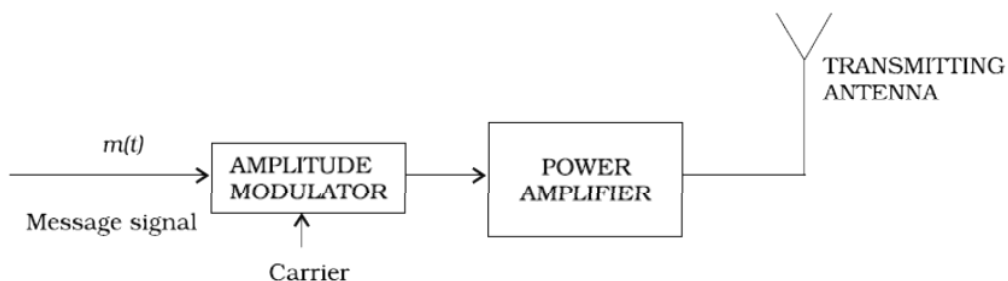

- **Receiver:**

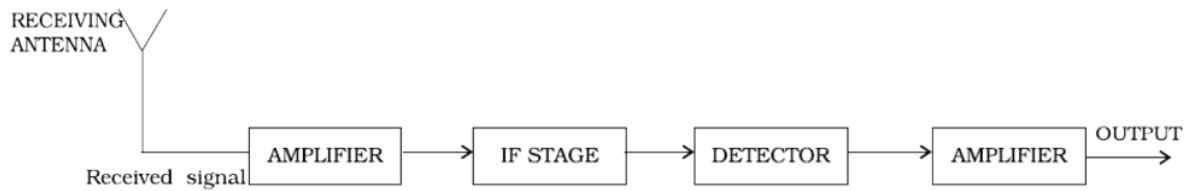

- **Detection of an AM signal:**

AM detection, which is the process of recovering the modulating signal from an AM waveform, is carried out using a rectifier and an envelope detector.

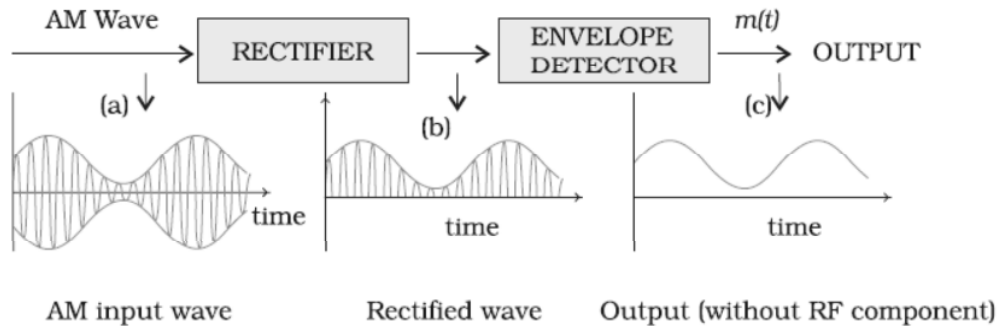

- **Internet:**

It permits communication and sharing of all types of information between any two or more computers connected through a large and complex network.

The application includes,

- | | | |
|------------------|----------------|---------|
| a) E- mail | c) WWW | e) Chat |
| b) File transfer | d) E- commerce | |

- **Mobile Telephony:**

The concept of this system is to divide the service area into a suitable number of cells centred on an office called MTSO (Mobile Telephone Switching Office). Each cell contains a low-power transmitter called a base station and caters to a large number of mobile receivers (popularly called cell phones). When a mobile receiver crosses the coverage area of one base station, it is necessary for the mobile user to be transferred to another base station. This procedure is called handover or handoff.

- **Facsimile (FAX):**

It scans the contents of a document (as an image, not text) to create electronic signals. These signals are then sent to the destination (another FAX machine) in an orderly manner using telephone lines. Then the signals are reconverted into a replica of the original document.