

ANSWERS

Unit 1

1. (d) 2. (c) 3. (d) 4. (d) 5. (b) 6. (c)
7. (c) 8. (c) 9. (a) 10. (b) 11. (a) 12. (c)
13. (d) 14. (a) 15. (b) 16. (d) 17. (c) 18. (c)
19. (a) 20. (a) 21. (d) 22. (c) 23. (b) 24. (d)
25. (a) 26. (c) 27. (d) 28. (c) 29. (d) 30. (b)
31. a 32. 0 33. 3140 34. -3, 8, (-8), 8 35. D
36. y, x, z 37. 0 38. 3 39. 11, 5, -55 40. -180
41. 23 42. Whole, Negative 43. Even 44. Positive
45. Negative 46. 1 47. (-1) 48. 50 49. -210
50. 45 51. 12, 5 52. 23, 1, -100, 1 53. 35 54. -47
55. -1 56. -1 57. -2 58. 40 59. Minus
60. Negative integer 61. Multiplication 62. -5 63. 10
64. -45 65. 83 66. -75 67. -1 68. -113 69. -1
70. -1 71. 1 72. True 73. False 74. True 75. False
76. False 77. True 78. True 79. True 80. False 81. True
82. True 83. True 84. False 85. False 86. False 87. True
88. False 89. True 90. False 91. False 92. True 93. True
94. False 95. True 96. True 97. False 98. True 99. True
100. False 101. False 102. True 103. True 104. True 105. False
106. False 107. True 108. False
109. (a) $-5 \times 2 = \underline{-10} = -15 - (-5)$
 $-5 \times 1 = \underline{-5} = \underline{-10} - (-5)$

$$-5 \times 0 = 0 = \underline{-5} - \underline{(-5)}$$

$$-5 \times -1 = 5 = \underline{0} - \underline{(-5)}$$

$$-5 \times -2 = \underline{10} = \underline{5} - \underline{(-5)}$$

$$(b) 7 \times 3 = \underline{21} = 28 - 7$$

$$7 \times 2 = \underline{14} = \underline{21} - 7$$

$$7 \times 1 = 7 = \underline{14} - 7$$

$$7 \times 0 = \underline{0} = \underline{7} - \underline{7}$$

$$7 \times \underline{-1} = \underline{-7} = \underline{0} - \underline{7}$$

$$7 \times \underline{-2} = \underline{-14} = \underline{-7} - \underline{7}$$

$$7 \times \underline{-3} = \underline{-21} = \underline{-14} - \underline{7}$$

110. (a) 0 (b) +1 (c) -1 **111.** -1, -10, +3, -2

112. (a) 725 years (b) 71 years (c) 1383BC (d) Archimedes

113. Antarctica, Asia, N. America, Europe, S. America, Africa, Australia.

114. -2, 6 **115.** $-5 \rightarrow 3$, $6 \rightarrow -2$, $-7 \rightarrow 1$, $8 \rightarrow -1$, **116.** -3, 12

117. (a) \rightarrow (vi), (b) \rightarrow (iii), c \rightarrow (v), d \rightarrow (vii), e \rightarrow (viii), f \rightarrow (iv)
g \rightarrow (ii), h \rightarrow (ix), i \rightarrow (i)

118. ₹ $[500 + 200 + 150 - 120 - 240] = ₹ 490$

119. (a) A number of solutions can be possible e.g., $4 + (-6) = -2$

(b) A number of solutions can be possible e.g., $8 + (-2) = 6$

(c) A number of solutions can be possible e.g., $-7 - (2) = -9$

(d) A number of solutions can be possible e.g., $4 - (-3) = 7$

(e) A number of solutions can be possible e.g., $-12 - (-7) = -5$

(f) A number of solutions can be possible e.g., $-4 + (-7) = -11 < -10$

(g) A number of solutions can be possible e.g., $-1 - 4 = -5 < -4$

(h) A number of solutions can be possible e.g., $-8 - (-9) = 1 > -6$

(i) A number of solutions can be possible e.g., $-2 - (-10) = 8$

(j) A number of solutions can be possible e.g., $-20 - (-9) = -11$

(k) A number of solutions can be possible e.g., $-3 \times 5 = -15$

(l) A number of solutions can be possible e.g., $4 \times 6 = 24$.

120. Ramu went wrong in solving $-(-3)$ and took it as -3 only.

121. Reeta went wrong in solving $+(-6)$ and took it as $+6$.

122. (a) C (b) D (c) A, C, B, D **123.** 356 m. **124.** (i) -3561

(ii) -4300 (iii) 5300 (iv) -1360 **125.** (i) 49 (ii) 28

- 126.** (i) $4 \Delta (-3) = 21$, $(-3) \Delta 4 = 28$, No
 (ii) $(-7) \Delta (-1) = -6$, $(-1) \Delta (-7) = 42$, No

- 127.** (a) $v = 1$
 (b) $w = 0$
 (c) $x = 4$

128. 2500m **129.** Hydrogen -259°C , Krypton -157°C ,
 Oxygen -223°C , Helium -272°C , Argon -189°C **130.** Fatima.

131. Net profit ₹ 27 **132.** (i) 10 (ii) 30 **133.** Since Yash scored 94 marks So, Minimum correct responses = $94 \div (+2) = 47$, Two possibilities are there:

1. Correct answer 47, unattempted 3
2. Correct answer 48, unattempted, wrong answer 1

134. 60 sec or 1 min **135.** 23rd January **136.** 19,759 m

(D)

Puzzle 1

(i)

-1	-9	4
3	-2	-7
-8	5	-3

(ii)

7	-2	-6	-1
-4	-3	1	4
0	-2	-3	3
-5	5	6	-8

Puzzle 2

- (i) -10 (iv) -3
 (ii) 8 (v) -33
 (iii) 7 (vi) 18

Increasing order

$$-33 < -10 < -3 < 7 < 8 < 18$$

E U C L I D

Puzzle 3

Solution: September

Puzzle 4

(a)

Puzzle 5

(a) 6 (b) -2 (c) -8

Puzzle 6

Arrange -12 in the centre and -2, 4, -5, 50, -25, 20 in clockwise order.

Unit 2

1. (b) 2. (c) 3. (c) 4. (b) 5. (d) 6. (a)
7. (c) 8. (b) 9. (d) 10. (c) 11. (b) 12. (d)
13. (c) 14. (d) 15. (c) 16. (b) 17. (d) 18. (a)
19. (c) 20. (b) 21. $\frac{1}{7}$ 22. $\frac{7}{3}$ 23. 18 24. 36
25. $\frac{76}{3}$ or $25\frac{1}{3}$ 26. $\frac{15}{7}$ 27. $\frac{2}{15}$ 28. $\frac{17}{9}$ or $1\frac{8}{9}$ 29. $\frac{1}{5}$
30. 10 31. X 32. 32 33. 25400 34. 9350 35. 0.47
36. 0.047 37. 0.0047 38. Less 39. multiply, reciprocal 40. 4
41. 100 42. X 43. X 44. 667 45. False 46. False
47. False 48. False 49. True 50. True 51. True 52. True
53. False 54. False 55. Yes, increase
56. The value of fraction would increase 57. D 58. 26.25 59. $\frac{2}{5}$
60. $\frac{5}{12}$ part 61. 24 pages 62. $\frac{5}{14}$ 63. Greater than 1.5
64. convert both into (1) decimals (2) fractions
65. (a) $\frac{16}{25}$ gram (b) $\frac{2}{5}$ gram 66. (a) 1 tsp (b) $1\frac{1}{2}$ tsp (c) 2 tsp
67. 24 boxes 68. 142 book marker 69. (a) 11.74 cm (approximatly)
- (b) 11.14cm (approximatly) 70. (a) 10.15 cm (b) 6.10 cm

71. (a) 58.718 cm (b) 40.506 cm 72. ₹ 1471.25 73. (a) D, (b) E
- (c) $\frac{3}{6}$ or $\frac{1}{2}$ or middle 74. 741.6 km (approximety) 75. 1
76. $\frac{27}{125}$ 77. $\frac{18}{31}$ 78. 2 79. 64 80. ₹ 114.30 81. 4.5°F
82. (i) 1964, 1965, 1978, 1958, 2002
(ii) 1946 should fall between 1965 and 1978
83. (a) 14.9920 (b) 11.9970 (c) 2.9950
84. Ravi + 0.01 cm, Kamal -0.08 cm, Tabish - 0.06 cm
85. 7.41 86. 70720 87. ₹ 104625 88. $\frac{1}{4}$ m 89. 90 bricks
90. $14\frac{1}{4}$ m 91. first usher 92. ₹ 23.15
93. 3.27 minutes 94. 11 days 95. 0.93 kg
96. (a) 90 (b) 74 (c) 50 97. $\frac{7}{8}$ L
98. $\frac{1}{6}$ part of work, $\frac{5}{6}$ part of work, complete work
99. $\frac{1}{5}$, $\frac{23}{25}$, $\frac{7}{10}$ 100. 5 pillows
101. 4 shirts 102. 3 hours 103. 600 km 104. ₹ 200
105. (i) (a) $\frac{5}{13}$ (b) $\frac{10}{13}$ (ii) (c) 7 tonnes 106. 5.1875
107. (1) → (d) (2) → (f) (3) → (c) (4) → (b) (5) → (a) (6) → (e)
108. 0.05 109. 2.4 110. 24.15 111. $\frac{20}{3}$ cm or $6\frac{2}{3}$ cm 112. $\frac{1}{3}$
113. $305\frac{19}{25}$ cm² 114. ₹ 300 115. 76 m 116. 10.816
117. Greater than 1: $\frac{2}{3} \div \frac{1}{2}$, $6 \div \frac{1}{4}$, $4\frac{1}{3} \div 3\frac{1}{2}$, $\frac{2}{3} \times 8\frac{1}{2}$

Less than 1: $\frac{2}{3} \div \frac{2}{1}$, $\frac{1}{5} \div \frac{1}{2}$

118. 37.5 119. $\frac{7}{648}$ 120. $\frac{3}{2}$ 121. 500 122. 0.00001

123. Error $-0.30 > -0.25$

124. mixed fractions are not converted into improper fraction. 125. $\frac{1}{7}$

(D)

1.

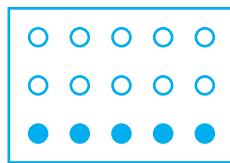

(a)

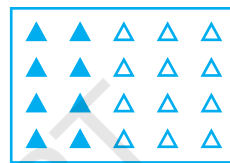

(b)

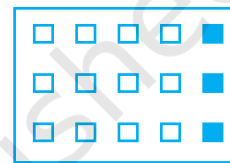

(c)

2.

(i)

$$\frac{1}{4} \times \frac{1}{3}$$



$$\frac{1}{3}$$



$$\frac{1}{4} \times \frac{1}{3} = \frac{1}{12}$$

(ii)

$$\frac{1}{3} \times \frac{1}{5}$$



$$\frac{1}{3}$$

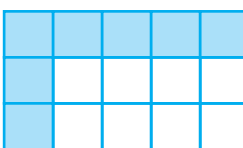

$$\frac{1}{3} \times \frac{1}{5} = \frac{1}{15}$$

(iii)

$$\frac{1}{2} \times \frac{1}{5}$$

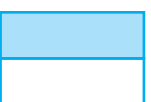

$$\frac{1}{2}$$



$$\frac{1}{2} \times \frac{1}{5} = \frac{1}{10}$$

3.

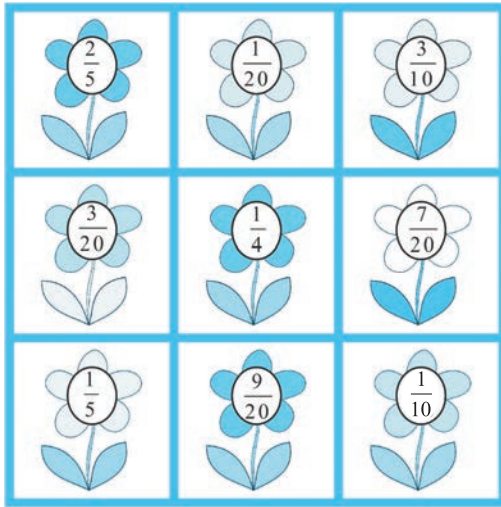

4. Sleep→8hrs, Study→3hrs, Meals→2hrs, School→7hrs and Personal time 4 hrs.

5.

Sl.No.	Ingredients	Given for One Cake	Triple Amount of Cake	Half Amount of Cake
(a)	Sugar	2 Cups	6 Cups	1 Cup
(b)	Milk	$\frac{3}{4}$ Cup	_____	_____
(c)	Coconut	1 Cup	_____	_____
(d)	Salt	$\frac{1}{8}$ Teaspoon	_____	_____
(e)	Cocopowder	1 Tablespoon	_____	_____
(f)	Butter	$1\frac{1}{2}$ Tablespoon	_____	_____
(g)	Eggs	2	_____	_____

7.

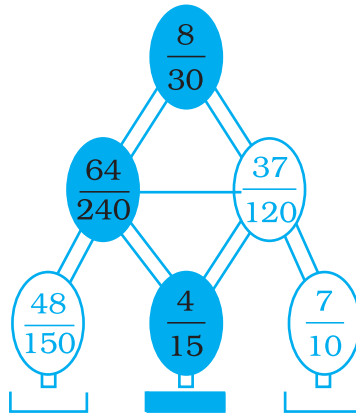

8.

Box 1	Box 2	Box 3
0.096	0.376	1.808
0.001	0.4200	0.987
0.066	0.62	11.00
0.0864	0.578	0.888

9.

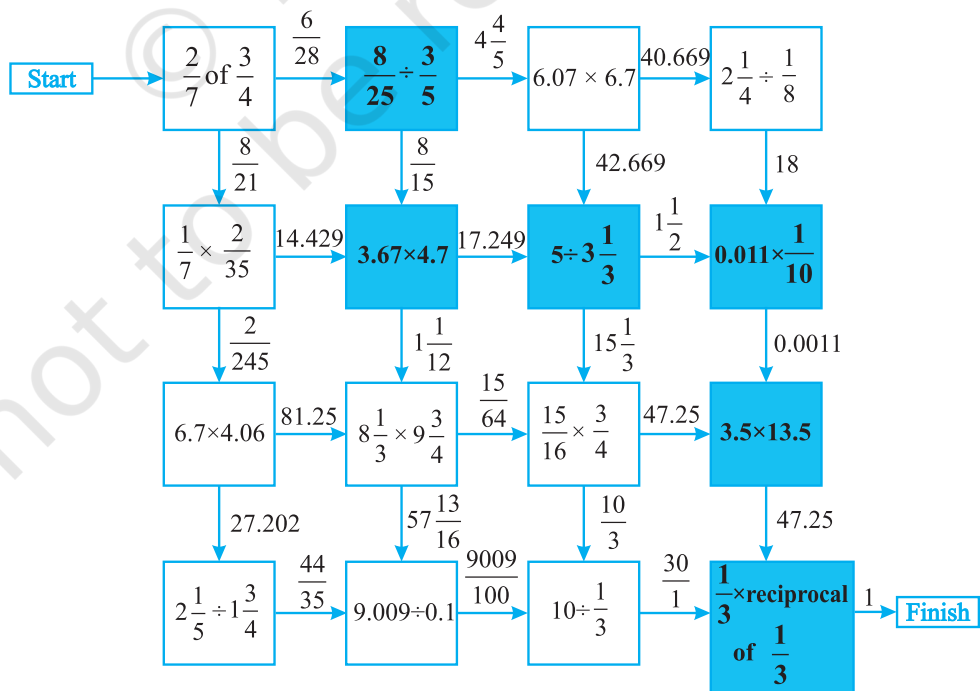

10. 1. 20 cm
 2. $\frac{40}{9}$ cm
 3. Length of bottom of vertical support = 9 cm
 Length of upper of vertical support = 3 cm

11.

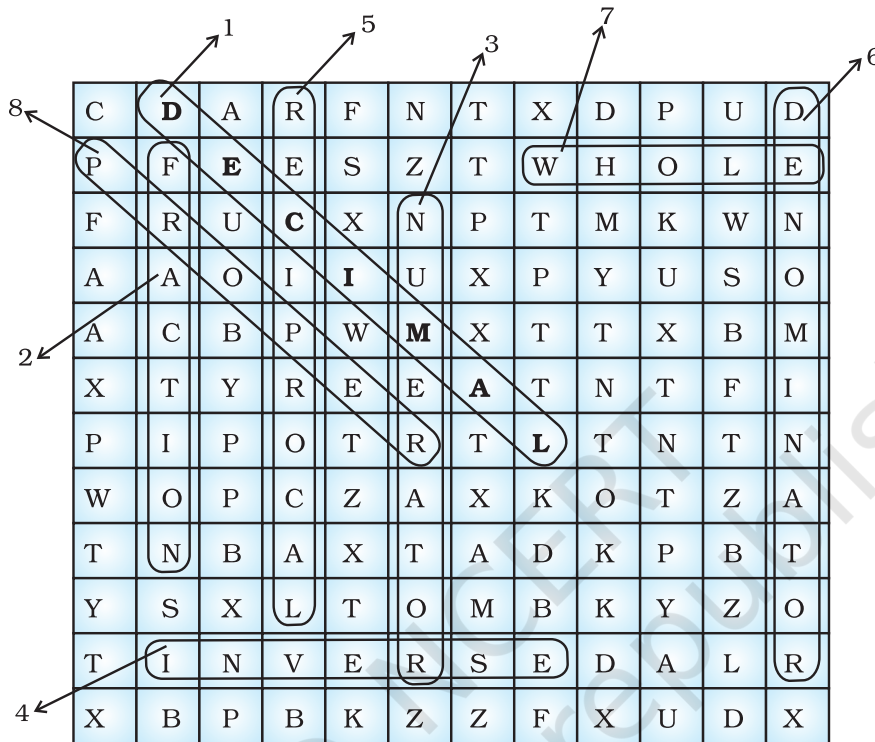

12.

- Across** : 1. Proper
 2. Denominator
 3. Equivalent
 4. Greater
 5. Improper
 6. One
- Down** : 1. Product
 2. Decimal
 8. Reciprocal
 9. Fraction

13.

(i) $\frac{1}{2} + \frac{1}{4}$ (ii) $\frac{1}{8} + \frac{1}{2}$ (iii) $\frac{1}{2} + \frac{1}{3} + \frac{1}{12}$ (iv) $\frac{1}{3} + \frac{1}{11} + \frac{1}{231}$ (v) $\frac{1}{1} + \frac{1}{5} + \frac{1}{15}$

Unit 3

1. (b) 2. (c) 3. (a) 4. (a) 5. (c) 6. (b)
 7. (c) 8. (b) 9. (c) 10. (b) 11. (b) 12. (d)
 13. (a) 14. (d) 15. (c) 16. (d) 17. Range
18. $\frac{\text{Sum of all observations}}{\text{Number of observations}}$ 19. Mode 20. Median
21. Central tendency 22. 1 23. 0 24. 1 25. 6
26. A double bar graph 27. Bar graph 28. 3
29. Minimum, Maximum 30. Odd 31. 52–55 32. False 33. True
34. False 35. False 36. True 37. True 38. False 39. True
40. False 41. False 42. True 43. True 44. False 45. False
46. False 47. True 48. False 49. False 50. 10, 10, 10, Yes
51. 11
52. (Mode is the observation that occurs most frequently in a set of observation).
53. (a) Black (b) Mode 54. (a) 25 (b) 30.41 (c) 33 55. (a) 65.6
- (b) 4 (c) 30 56. (a) 1 (b) $\frac{2}{5}$ (c) $\frac{1}{5}$ (d) 0 57. 4 58. 4.5 59. One
60. Blue 61. $\frac{4}{7}$ 62. $\frac{1}{6}$
63. (a) Impossible to happen.
 (b) May or may not happen.
 (c) May or may not happen.
 (d) Certain to happen.
 (e) Impossible to happen.
 (f) Certain to happen.
64. Mean = 3.13, Median = 3, Mode = 2 65. 14 66. 10
67. 11.14 68. 8
69. (a) 154 cm
 (b) 128 cm
 (c) 26 cm
 (d) 142 cm



- 70.** (a) 8 or 17 or 16 (except 15)
(b) Two times 15
(c) Three times 17
- 71.** (a) Group A Mode = 7 and 10
Range = 3
Group B
Mode = 12
Range = 5
(b) Range = 5, Mode = 7 and 12
- 72.** (a) Production of motor bikes by XYZ Automobiles Ltd. during January to June.
(b) 2100 (c) 300
(d) June, 500 (e) 767 bikes (nearest whole numbers)
- 73.** (a) 4 (b) 18
(c) 4 (d) 10
(e) 42
- 74.** (a) The production of rice (in million tonnes) by a country during the years 2005 to 2009.
(b) 2006 (c) 2006
(d) 54 million tonnes (e) 10 million tonnes
- 75.** (a) Marks obtained by a students in different subjects.
(b) Maths (c) 68.2
(d) Hindi, Maths (e) 68.2%
- 76.** (a) 1800 (b) 300
(c) Tamil (d) 2300
- 77.** (a) Cricket (b) 17
(c) 65 (d) Cricket
(e) 4 sports (hockey, football, tennis, badminton)
(f) 14 : 7 or 2 : 1
- 78.** (a) Comparison of sales of brand A and brand B during the month of January to June.
(b) March (c) 3 Lakh
(d) 41.8 Lakh (e) April, June
(f) 31 : 36
- 79.** (a) Comparison of minimum temperature during the months November to February for the years 2008 and 2009.
(b) 18 :15 or 6:5 (c) Two February and November
(d) 11.25 (e) February

- 80.** Give the double bar graph here
- 81.** (a) number of students (boys and girls) in different section of Class VII.
 (b) 110 boys (c) Sections VII A and VII D
 (d) VII B (e) VII C
- 82.** (a) Give the double bar graph here
 (b) Thursday (c) 200
- 83.** (a) Give the double bar graph here
 (b) VIII (c) X
 (d) 13 :14 (e) 10%
- 84.** (a) Give the bar graph here
 (b) Saturday (c) 267
 (d) 9:20 (e) 44.5
 (f) 4 days (Monday, Tuesday, Thursday, Saturday)
- 85.**
- | (a) Building | Height | No. of stories | Height of each storey |
|------------------------|--------|----------------|-----------------------|
| MVRDC | 156 | 35 | 4.45 |
| Oberoi woods tower II | 170 | 40 | 4.25 |
| Oberoi woods tower III | 170 | 40 | 4.25 |
| RNA Nirage | 180 | 40 | 4.25 |
| Planet Godrej | 181 | 51 | 3.5 |
| UB Tower | 184 | 20 | 9.2 |
| Ashok Tower | 193 | 49 | 3.9 |
| The Imperial I | 249 | 60 | 4.15 |
| The Imperial II | 249 | 60 | 4.15 |
- 86.** (a) Give bar graph here
 (b) 84% (c) 81.6%
 (d) 34 : 35
 (e) Three subjects(English, Hindi and S.Sc.)
 (f) Soni, 11 marks
 (g) In English and Science 14 marks.
- 87.** (a) Give the double bar graph here
 (b) 210 (c) Electronics
 (d) Yoga (e) Yoga, Dramatics
 (f) Fine Arts

- 88.** (a) Give the double bar graph here
 (b) In year 2007 (c) 4420
 (d) May (e) August
 (f) February
- 89.** (a) Give the double bar graph here
 (b) Town D (c) Town A
- 90.** (a) Give double bar graph here
 (b) Mussoorie (c) Manali
 (d) Manali, Nainital, Mussoorie, Kullu
- 91.** (a) Give double bar graph here
 (b) Butterscotch (c) 46 (d) 21 (e) 5 : 6

Unit 4

- 1.** (c) **2.** (a) **3.** (d) **4.** (d) **5.** (c) **6.** (d)
7. (b) **8.** (d) **9.** (a) **10.** (a) **11.** (c) **12.** (d)
13. (c) **14.** (c) **15.** (b) **16.** (a) **17.** (c) **18.** (b)
19. (a) $60 - x$ (b) $60 - 2x$ (c) $-2x = 30$
 (d) 15 (e) 45, 15
20. (a) $81 - x$ or $2x$ (b) $2x = 81 - x$ (c) $x = 27$ (d) 54, 27
21. (a) $2x$ (b) $4x + 3x = 280$ (c) $x = 40$ (d) 80
22. (a) $2x$ (b) $6x$ or $2(2x + x)$ (c) $6x = 60$ (d) $x = 10$
23. (a) ₹ $5x$ (b) ₹ $2x$ (c) $5x + 2x = 70$ (d) 10, 10
24. (a) $30 - x$ (b) $2000x + 1000(30 - x)$ (c) $1000x + 30000 = 52000$
 (d) $x = 22$ (e) 22, 8 **25.** 2 **26.** $x = 3$ **27.** $x = -1$ **28.** 5
29. No **30.** No **31.** No **32.** One **33.** $3x + 5 = 4x - 7$
34. $x = 3$ **35.** 4 **36.** 0 **37.** -3 **38.** 4
39. Satisfies, root **40.** sign **41.** 2 **42.** 7 **43.** 0
44. 0 **45.** 75 **46.** 25 **47.** 72 **48.** $\frac{7}{4}$ **49.** True
50. False **51.** False **52.** False **53.** True **54.** False **55.** False
56. (i) \leftrightarrow (C) (ii) \leftrightarrow (E) (iii) \leftrightarrow (F) (iv) \leftrightarrow (D) (v) \leftrightarrow (B) (vi) \leftrightarrow (A)

57. $2x - 13 = 3$ 58. $\frac{x}{5} = x - 5$ 59. $x = 7 + \frac{x}{3}$ 60. $6x = 10 + x$
61. $\frac{x}{2} - 10 = 4$ 62. $p - 5 = 2$ 63. $5x + 7 = 27$ 64. $x + (x + 3) = 43$
65. $\frac{1}{2}(x-1) = 7$ 66. $\frac{x}{2} + 5 = 9$ 67. $2x + 4 = 18$ 68. 9 years
69. 30, 42 70. 2 71. ₹ 20 72. ₹ 425 73. 560
74. 2 75. 2 76. 6 77. $6\frac{1}{4}$ years
78. 5 years 79. 18 years 80. 18 81. 16 kg, 64 kg 82. 72
83. 6 84. 4, 8 85. 1, 2, 3 86. 36 87. 16 m
88. 6 cm, 12 cm, 12 cm 89. 8, 10 90. $35^\circ, 55^\circ$ 91. 50, 100
92. 45, 15 93. 9 94. 50 95. 180 km 96. 9.6
97. 6 98. 11 years, 39 years 99. width = 30 cm, length = 60 cm
100. ₹ 30 101. 1867 102. ₹ 13740 103. 16
104. (a) $X - V = V$ (b) $VI + IV = X$, $VI + V = XI$ 105. $i = 1$, $u = 4$,
 $a = 5$, $q = 3$, $t = 2$, $s = 8$, $p = 9$, $c = 6$, $k = 7$ 106. $\Delta = 7$, $* = 4$
107.  = 6 kg,  = 10 kg

(D)

1.

⁶ 1					
¹ 9			¹⁰ 7	8	⁴ 3
	⁵ 5	² 5			0
	³ 1	0	⁹ 8		0
⁸ 4			⁷ 4	9	0
3		¹¹ 1			
	¹² 1	2	5		

2.

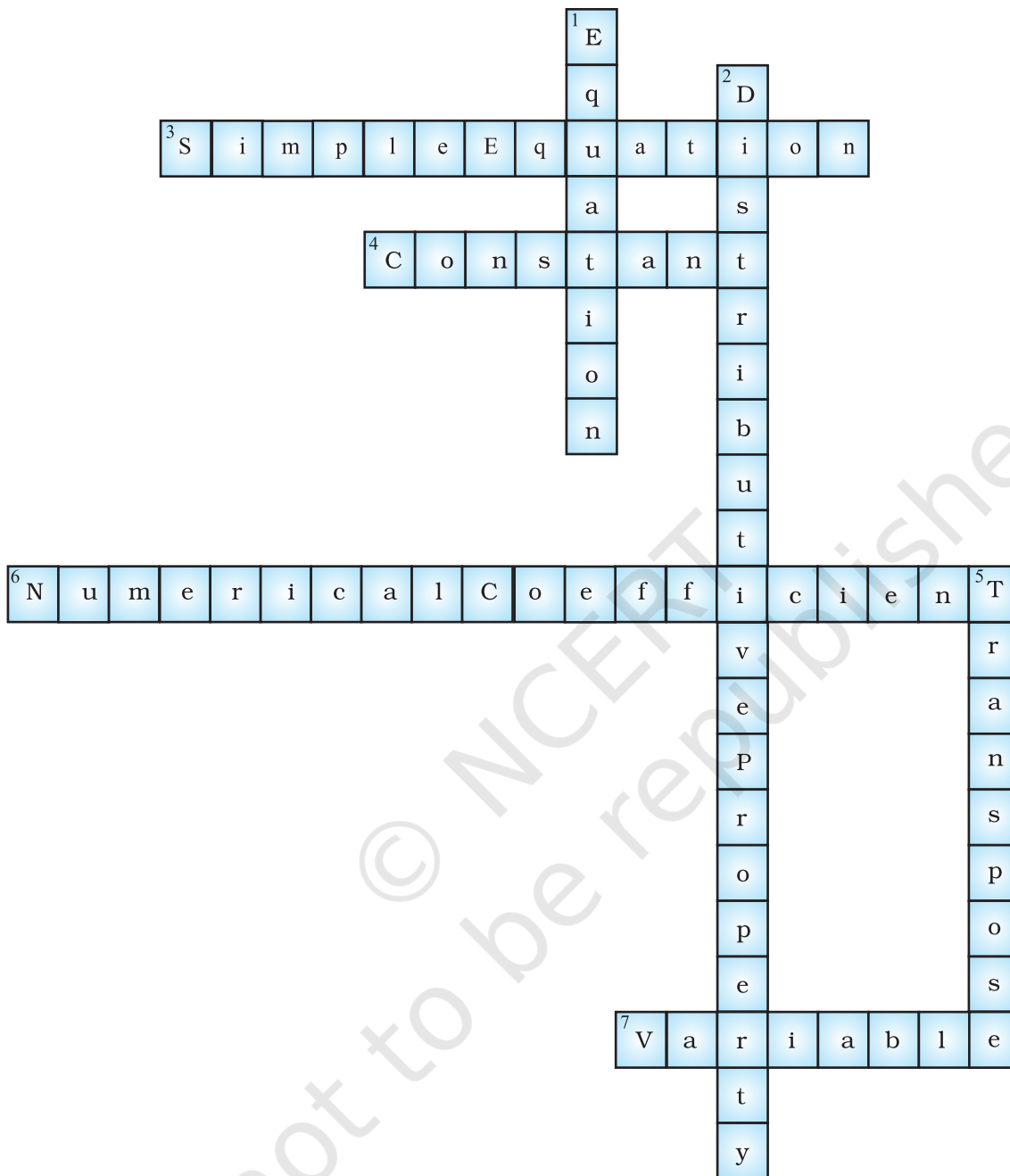

3.

First you must split the pearls into equal groups. Place any three pearls on one side of the scale and any other three on the other side. If one side weighs less than the other, then the fake pearl is on that side. But you are

not done yet! You still need to find the imitation, and you can use the scale only once more. Take any of the two pearls from the lighter pan, and weigh them against each other. If one pan is lighter, then that pan contains the fake pearl. If they balance, then the leftover pearl of the group is the fake.

If the scale balances during the first weighing, then you know the fake is in the third group. Then you can choose two pearls from that group for the second weighing. If the scale balances, the fake is the one left. If it is unbalanced, the false pearl is the lighter one.

Unit 5

1. (b) 2. (c) 3. (b) 4. (b) 5. (b) 6. (d)
 7. (b) 8. (d) 9. (d) 10. (c) 11. (d) 12. (a)
 13. (a) 14. (a) 15. (b) 16. (c) 17. (b) 18. (a)
 19. (a) 20. (c) 21. (a) 22. (b) 23. (b) 24. (a)
 25. (d) 26. (d) 27. (c) 28. (d) 29. (b) 30. (b)
 31. (c) 32. (d) 33. (a) 34. (a) 35. (c) 36. (b)
 37. (d) 38. (d) 39. (c) 40. (b) 41. (a)
 42. Complementary 43. Supplementary 44. Distinct
 45. 180° 46. Arm 47. Same 48. Opposite 49. Parallel
 50. Linear 51. Obtuse 52. Right angle 53. Acute 54. 90°
 55. 45° 56. 60° 57. False 58. False 59. False 60. True
 61. True 62. True 63. False 64. True 65. True 66. False
 67. False 68. True 69. False 70. True 71. False
 72. (i) (a) $\angle AOB, \angle BOC$ (b) $\angle AOB, \angle BOD$
 (c) $\angle BOC, \angle COD$ (d) $\angle AOC, \angle COD$
 (ii) (a) $\angle PQR, \angle PQT$ (b) $\angle SPR, \angle RPQ$
 (c) $\angle PRQ + \angle QRU$
 (iii) (a) $\angle TSV, \angle VSU$ (b) $\angle SVU, \angle SVT$
 (iv) (a) $\angle AOC, \angle AOD$ (b) $\angle AOD, \angle BOD$
 (c) $\angle BOD, \angle BOC$ (d) $\angle BOC, \angle AOC$
 73. (a) (i) $\angle 1, \angle 3; \angle 2, \angle 4; \angle 5, \angle 7; \angle 6, \angle 8$

- (ii) $\angle 1, \angle 2$; $\angle 2, \angle 3$; $\angle 3, \angle 4$; $\angle 4, \angle 1$; $\angle 5, \angle 6$; $\angle 6, \angle 7$;
 $\angle 7, \angle 8$; $\angle 8, \angle 5$
- (b) (i) NIL (ii) NIL
- (c) (i) _____ NIL
(ii) $\angle ABD, \angle DBC$; $\angle ABE, \angle EBC$
- (d) (i) $\angle ROQ, \angle POS$; $\angle ROP, \angle QOS$
(ii) $\angle ROP, \angle POS$; $\angle ROT, \angle TOS$; $\angle QOS, \angle SOP$; $\angle QOT, \angle TOP$;
 $\angle ROQ, \angle QOS$; $\angle ROQ, \angle ROP$
- 74.** (i) $\angle AOD, \angle AOC$; $\angle AOC, \angle BOC$; $\angle BOC, \angle BOD$; $\angle AOD, \angle BOD$
(ii) $\angle POS, \angle SOQ, \angle POR, \angle QOR$
(iii) $\angle 1, \angle 2$; $\angle 3, \angle 4$; $\angle 5, \angle 6$
- 75.** $\angle QUR = 138^\circ$ **76.** (a) 4 (b) 4 (c) (i) $45^\circ, 45^\circ$ (ii) $60^\circ, 30^\circ$
- 77.** 83° **78.** 90°
- 79.** (a) $\angle TQS, \angle SQR$
(b) $\angle SQR, \angle SQP$; $\angle TQR, \angle TQP$;
(c) $\angle SQR, \angle SQT$; $\angle TQR, \angle TQP$; $\angle SQT, \angle TOP$; $\angle PQS, \angle SQR$
- 80.** (i) $\angle x, \angle y$; $\angle x + \angle y, \angle z$; $\angle y, \angle z, \angle y + \angle z, \angle x$
(ii) $\angle x = \angle y = \angle z, \angle x, \angle y, \angle z, \angle z, \angle x$
- 81.** (a) 13
(b) Linear pair, Supplementary, Vertically opposite. Angles, Adjacent angles.
(c) Vertically opposite angles – (1, 3); (2, 4)
Linear Pairs: 1,2; 2,3; 3,4; 4,1.
- 82.** (a) Yes (b) No (c) No (d) No
- 83.** $\angle 7, \angle 2$; $\angle 1, \angle 8$; $\angle 5, \angle 6$; $\angle 6, \angle 3$; $\angle 3, \angle 4$; $\angle 4, \angle 5$
- 84.** (a) obtuse
(b) acute
(c) right angle
- 85.** No **86.** $\angle 1, \angle 2$; $\angle 2, \angle 3$; $\angle 3, \angle 4$; $\angle 4, \angle 1$. **87.** 152°
- 88.** $\angle a = 30^\circ, \angle b = 150^\circ, \angle c = 150^\circ$ **89.** $\angle x = 35^\circ, \angle y = 145^\circ$
- 90.** (i) 30° (ii) 105° (iii) 75° (iv) 75°
- 91.** $\angle x = 60^\circ, \angle y = 120^\circ, \angle z = 60^\circ$ **92.** $\angle EFD = 70^\circ$
- 93.** $\angle AOD = 139^\circ$ **94.** 110° **95.** $44^\circ, 46^\circ$ **96.** $100^\circ, 80^\circ$

Unit 6

1. (d) 2. (c) 3. (b) 4. (c) 5. (d) 6. (c)
 7. (c) 8. (c) 9. (c) 10. (a) 11. (c) 12. (b)
 13. (b) 14. (c) 15. (c) 16. (d) 17. (a) 18. (d)
 19. (b) 20. (c) 21. (c) 22. (c) 23. (b) 24. (a)
 25. (c) 26. (b) 27. (d) 28. (b) 29. (c) 30. (d)
 31. (c) 32. (b) 33. (a) 34. (d) 35. (d) 36. (b)
 37. (b) 38. (d) 39. (d) 40. (c) 41. (b) 42. (b)
 43. (b) 44. (d) 45. (b) 46. (c) 47. (a) 48. (b)
 49. (c) 50. Obtuse 51. a right angle 52. hypotenuse
 53. Altitude 54. 60° 55. equal 56. equal 57. 90° 58. two
 59. equal 60. congruent 61. Length and breadth 62. side
 63. (i) $\angle Z$ (ii) XZ (iii) $\angle Y$ (iv) XY (v) X (vi) ZY 64. $\triangle XZY$
 65. $\triangle RSP$ 66. $\triangle DRQ$ 67. $\triangle PQO$ 68. (i) $\triangle ADC$, (ii) DC, (iii) $\angle DCA$,
 (iv) $\angle BAD$ and $\angle BCD$ 69. (i) $\angle PQR + \angle PRQ$ (ii) $\angle QRP + \angle QPR$
 70. False 71. False 72. True 73. False 74. False 75. False
 76. False 77. True 78. False 79. False 80. True 81. False
 82. False 83. True 84. False 85. False 86. False 87. True
 88. False 89. True 90. False 91. True 92. True 93. True
 94. False 95. True 96. True 97. True 98. False 99. True
 100. False 101. True 102. False 103. False 104. True 105. False
 106. False 107. $100^\circ, 60^\circ, 20^\circ$ 108. 35° 109. (i) $a = 20^\circ$,
 $b = 130^\circ, c = 50^\circ$, (ii) $a = 65^\circ, b = 115^\circ, c = 25^\circ$ 110. $y = 30^\circ$
 111. $\angle A = 30^\circ$ 112. Triangle, Obtuse angled triangle 113. 10 km
 114. 40 m 115. $\angle Q = 75^\circ, \angle R = 75^\circ$ 116. $\angle x = 75^\circ, \angle y = 135^\circ$
 117. $\angle PON = 90^\circ, \angle NPO = 20^\circ$ 118. $x = 70^\circ, y = 80^\circ$ 119. 50°

148. (i) $\triangle PQR \cong \triangle TUS$ (ii) Not congruent
 (iii) $\triangle BCD \cong \triangle BAE$ (iv) $\triangle STU \cong \triangle XZY$
 (v) $\triangle DOF \cong \triangle HOC$ (vi) Not congruent
 (vii) $\triangle PSQ \cong \triangle RQS$ (viii) $\triangle LMN \cong \triangle OMN$

149. (i) $\triangle PQR \cong \triangle STU$ (ii) Not congruent

150. (i) Yes, (SAS)

(ii) Yes, CPCT

151. Yes, (SAS) 152. yes, (ASA)

153. (i) Yes, (ASA)

(ii) Yes, CPCT

(iii) Yes, CPCT

154. (i) Yes, (RHS)

(ii) Yes, CPCT

155. 38m 156. 12m 157. 6m

158. $AB = EO$, $\angle ABC = \angle EOD = 90^\circ$, $CA = DE$, yes, (RHS)

(D)

6.

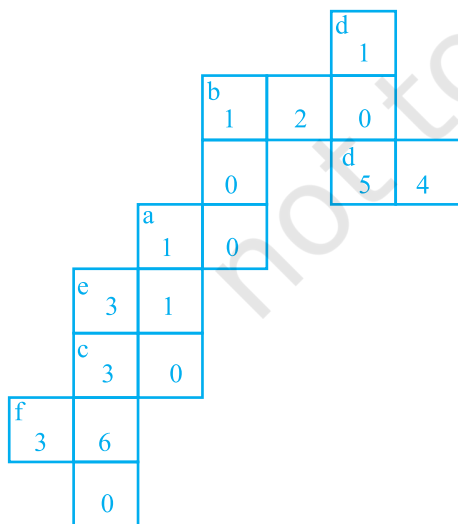

7.

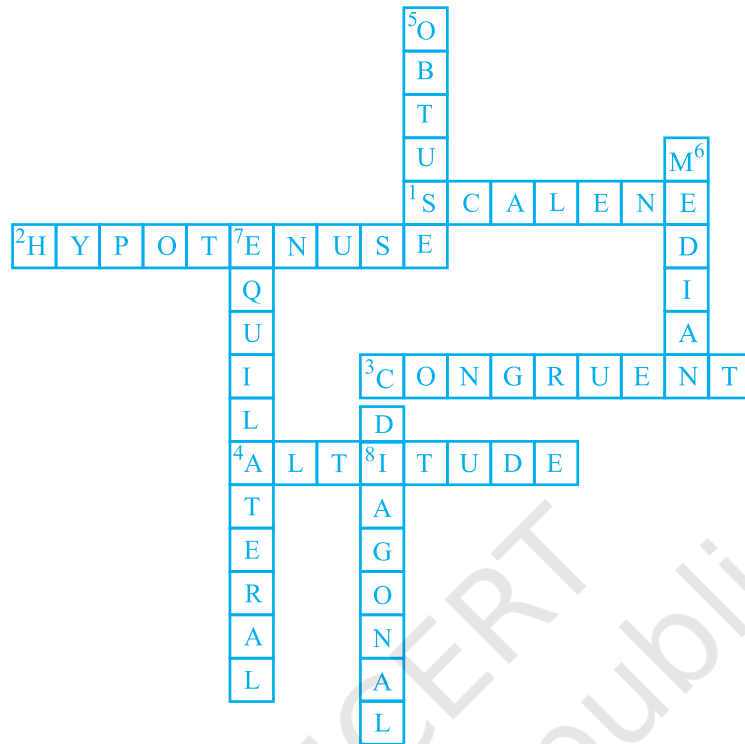

Unit 7

1. (d) 2. (c) 3. (a) 4. (b) 5. (c) 6. (a)
 7. (c) 8. (b) 9. (a) 10. (b) 11. (a) 12. (c)
 13. (c) 14. (d) 15. (b) 16. (c) 17. (d) 18. (b)
 19. (d) 20. (c) 21. (c) 22. (c) 23. (a) 24. $66\frac{2}{3}$
 25. 3 : 16 26. ₹ 108 27. 60 km 28. 250 29. 160
 30. fraction 31. 30 32. 10 33. 46 34. 88 35. 900
 36. 90 37. ₹ 83 38. ₹ 96 39. ₹ 8100 40. $7\frac{1}{7}$
 41. Profit, 10 42. Loss 10 43. ₹ 5355000 44. Profit, 20
 45. Profit, 10 46. Profit, 14 47. ₹ 900 48. ₹ 20800

49. ₹ 5250 50. 0.5 51. 60
52. T = Time period, R% = Rate of Interest, P = Principal
53. ₹168 54. Multiply 55. Right 56. Sum 57. More
58. attached sheet
59. aattachd sheet
60. True 61. False
62. False 63. False 64. True 65. False 66. False
67. False 68. False 69. True 70. False 71. False 72. False
73. False 74. False 75. True 76. False 77. False 78. False
79. False 80. (i) 1250, (ii) 1250, (iii) 800, (iv) 900
81. (a) 75 (b) 75 (c) 17;51 (d) 30
82. 16.6% or $\frac{50}{3}\%$ 83. $22\frac{1}{2}\%$ 84. 1% 85. $\frac{4}{5}$ 86. 1 : 3
87. 1 : 6 88. 3 : 2 89. 364 90. 8.9% 91. 156%
92. 3 93. 6400 94. 500 95. 50% 96. 0.069%
97. 100% 98. 2kg 99. 125% 100. 15% 101. 1200
102. Carbon = 75g, Calcium = 250 g 103. 96 kg 104. gain of 18.5%
105. ₹ 7500 106. ₹ 800 107. ₹ 5760 108. 20% by Car,
80% by Train 109. ₹ 1600 110. ₹ 6750 111. ₹ 80,000
112. 8 : 25 113. ₹ 50,000 114. ₹ 12,000 115. 82
116. (a) 3:2 (b) 68 mm Hg (c) 259 : 169
117. (a) 9300 cm (b) 36 kg (c) 0.000000085
118. (a) 3 : 2; 3 : 2; 8 : 5; 8 : 3; 9 : 5
(b) 60%; 60%; 61.53% , 72.72%; 64.28%
119. $\frac{6}{10000}$ 120. $48 \neq 36$ 121. ₹ 256 122. 12.5%
123. 4.5m 124. Nancy 125. ₹ 25,000
126. 83% 127. ₹ 30,000 128. ₹ 756
129. (i) ↔ E, (ii) ↔ H, (iii) ↔ O, (iv) ↔ J, (v) ↔ G, (vi) ↔ L, (vii) ↔ B,
(viii) ↔ A, (ix) ↔ F, (x) ↔ K, (xi) ↔ D, (xii) ↔ I, 130. 25
131. ₹ 6000 and ₹ 4000 132. 12.5% 133. 30 years

134. ₹ 12,000

135. ₹ 5,000

137. 45

138. a) Mean = 1435000km², Median = 475000km², Mode = 3,10,000 km²

b) 4.19

c) 50%

d) 21.1%

139. 44528685 km²

140. Red = 37.5%, Blue 12.5%, Green = 50%

(D)

- (i) 1. Cost Price, 2. Interest, 3. Per cent, 4. Profit
5. Principal, 6. Proportion, 7. Selling Price, 8. Amount

- | (ii) | Across | Down | (iii) | Across | Down |
|------|---------|----------|-------|--------|--------|
| | 1. 20 | 6. 32 | | 1. 50 | 2. 24 |
| | 2. 1520 | 7. 6000 | | 2. 240 | 5. 104 |
| | 3. 72 | 8. 75 | | 3. 5 | 6. 40 |
| | 4. 3000 | 2. 1200 | | 4. 300 | 7. 9 |
| | 5. 25 | 9. 490 | | | |
| | | 10. 9000 | | | |
| | | 4. 385 | | | |
| | | 5. 216 | | | |

Unit 8

1. (d) 2. (c) 3. (d) 4. (b) 5. (a) 6. (b)
7. (c) 8. (c) 9. (c) 10. (c) 11. (b) 12. (c)
13. negative 14. positive 15. $\frac{2}{7}$ 16. $\frac{-3}{4}$ 17. left 18. right
19. smaller 20. smaller 21. different 22. same 23. $\frac{-2}{3}$ 24. $-\frac{1}{5}$
25. -1 26. $\frac{-1}{2}$ 27. 1 28. -36 29. 12 30. -1
31. < 32. > 33. < 34. < 35. = 36. zero
37. 1 38. $\frac{9}{49}$ 39. 0 40. 0 41. $\frac{-5}{2}$ 42. -1

43. $b \div m$ 44. positive, negative 45. simplest 46. zero
 47. True 48. True 49. True 50. False 51. True 52. True
 53. True 54. False 55. True 56. True 57. True 58. True
 59. False 60. False 61. True 62. False 63. True 64. False
 65. False 66. (i \leftrightarrow (c), (ii) \leftrightarrow (e), (iii) \leftrightarrow (a), (iv) \leftrightarrow (b), (v) \leftrightarrow (d)

67. $\frac{-5}{8}, \frac{-15}{28}, \frac{17}{13}$ 68. (i) $\frac{27}{36}$ (ii) $\frac{-60}{-80}$

69. (i) $\frac{-5}{6}$ (ii) $\frac{-1}{4}$ 70. (i) $\frac{2}{5}$, (ii) $\frac{-2}{7}$, (iii) $\frac{-3}{7}$, (iv) $\frac{-13}{7}$

71. Yes. Since standard form of $\frac{-8}{28} = -\frac{2}{7}$ and standard form of

$$\frac{32}{-112} = -\frac{2}{7}$$

72. $\frac{-7}{10}, \frac{2}{-3}, \frac{5}{-8}, \frac{-3}{5}, \frac{-1}{4}$



74. -20

75. (i) $\frac{-6}{8}, \frac{-9}{12}, \frac{-12}{16}$ (ii) $\frac{14}{22}, \frac{21}{33}, \frac{28}{44}$

76. (i) $\frac{20}{-25}, \frac{24}{30}, \frac{28}{-35}$ (ii) $\frac{-40}{35}, \frac{-48}{42}, \frac{-56}{49}$

77. $\frac{42}{56}, \frac{44}{56}, \frac{46}{56}, \frac{48}{56}$

78. (i) $\frac{127}{143}$, (ii) 1 79. (i) $\frac{83}{28}$, (ii) $\frac{9}{13}$

80. (i) $\frac{1}{3}$, (ii) $\frac{42}{11}$ 81. (i) -13, (ii) $\frac{3}{7}$

82. (i) $\frac{-55}{49}$ (ii) -2 83. (i) $\frac{7}{8}$ (ii) $3\frac{1}{9}$

84. It has more than one answer like $\frac{-78}{17}, \frac{-79}{18}$.

85. (i) $\frac{-11}{40}, \frac{19}{40}, -\frac{3}{80}, \frac{-4}{15}$

86. (i) $\frac{8}{25}$ (ii) $\frac{4641}{80}$ (iii) $\frac{-4}{15}$ (iv) $\frac{-3}{10}$

87.

+	$-\frac{1}{9}$	$\frac{4}{11}$	$-\frac{5}{6}$
$\frac{2}{3}$	$\frac{5}{9}$	$\frac{34}{33}$	$-\frac{1}{6}$
$-\frac{5}{4}$	$-\frac{49}{36}$	$-\frac{39}{44}$	$-\frac{25}{12}$
$-\frac{1}{3}$	$-\frac{4}{9}$	$\frac{1}{33}$	$-\frac{7}{6}$

88. $\frac{6}{8}, \frac{7}{2}, \frac{1}{1}, \frac{1}{4}, \frac{0}{1}, \frac{5}{3}$ 89. $\frac{m}{n}$

90. (a) $\frac{p}{q} < \frac{r}{s}$, (b) $p \times s = r \times q$, (c) $\frac{p}{q} > \frac{r}{s}$

91. (a) $\frac{-34}{48}$, (b) $\frac{-24}{4}$, (c) $\frac{-5}{17}$, (d) $\frac{1600}{81}$

92. (a) $\frac{7}{20}$, (b) $\frac{6}{5}$, (c) $\frac{-45}{7}$, (d) $\frac{-2}{7}$, (e) $\frac{5}{9}$

93. (a) 0, (b) $\frac{5}{36}$, (c) $\frac{-136}{234}$, (d) $\frac{3}{40}$

94. (a) $\frac{31}{36}$ (b) $\frac{1}{36}$ (c) $\frac{-5}{6}$ (d) $-\frac{48}{45}$ (e) -36

(f) $\frac{3}{20}$ (g) $\frac{-56}{135}$ (h) $-\frac{17}{36}$ (i) $\frac{13}{36}$ (j) $-\frac{56}{135}$

(k) $-\frac{5}{4}$ 95. $\frac{3}{2}$ 96. $\frac{1}{3}$ 97. $\frac{8}{5}$ 98. $\frac{-1}{2}$ 99. 16

100. 2.25m 101. (i) $\frac{-3}{20}, \frac{-6}{40}, \frac{-9}{60}$ (ii) $-5, \frac{-10}{2}, \frac{-15}{3}$

102.

Number	Natural No.	Whole No.	Integer	Fraction	Rational No.
-114			√		√
$\frac{19}{17}$				√	√
$\frac{623}{1}$	√	√	√	√	√
$-19\frac{3}{4}$					√
$\frac{73}{71}$				√	√
0		√	√	√	√

103. $\frac{49}{51}, 99$ 104. 45 105. $7 : 2; \frac{7}{2}$ 106. (d) 107. (c)

108. (b) 109. (a)

110. She divided numerator by 5 but denominator by -5

(D)

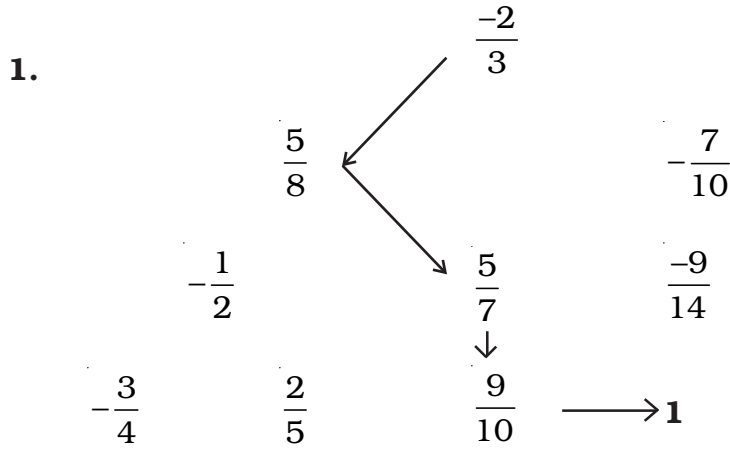

2.

$-\frac{1}{4}$	$-\frac{1}{6}$	0	$-\frac{1}{2}$	-1
$-\frac{3}{8}$	$-\frac{11}{60}$		-2	
$-\frac{1}{2}$	$-\frac{1}{5}$		$-\frac{5}{2}$	
$-\frac{5}{12}$	$-\frac{12}{70}$		-3	
$-\frac{1}{3}$	$-\frac{1}{7}$	-4	$-\frac{9}{2}$	-5

3. $\frac{-112}{224}$

4. (Make from graph)

Unit 9

1. (a) 2. (c) 3. (b) 4. (b) 5. (c) 6. (d)
 7. (d) 8. (a) 9. (d) 10. (c) 11. (a) 12. (c)
 13. (c) 14. (a) 15. (a) 16. (c) 17. (a) 18. (b)
 19. (c) 20. (c) 21. (b) 22. (c) 23. (d) 24. (b)

25. (d) 26. (b) 27. (b) 28. (c) 29. (b) 30. (c)

31. (b) 32. (a) 33. (a) 34. (b) 35. (b) 36. (a)

37. (a) 38. no. of sides 39. perimeter, area 40. 18cm^2

41. 35cm^2 42. base 43. height/altitude 44. circumference

45. π 46. 9 47. $3.14/\frac{22}{7}$ 48. π 49. r 50. 10000

51. 100 52. 10,000 53. Height 54. 10,00,000

55. 3,60,000 56. $\frac{1}{1000}$ or 0.001 57. True 58. (a) True (b) False,

(c) False (d) True 59. False 60. True 61. False 62. True

63. False 64. True 65. True 66. True 67. False 68. True

69. False 70. False 71. True 72. True 73. 540

74. 377.1498 75. 64m^2 76. 16.25m^2 77. 24 m 78. 8cm, 20cm^2

79. $XY = 6\text{ cm}$, $YZ = 8\text{ cm}$ 80. (i) 180m (ii) 2975m^2 81. 42 cm^2

82. circular pizza 83. 33 m 84. 450m^2 85. 30cm^2 86. 36 cm

87. 6 cm 88. 32 cm 89. $l = 9\text{m}$, and $m = 15\text{m}$, other side = 30m

90. 15 cm and 17 cm 91. 120 cm 92. 98 cm^2 93. 56cm^2

94. 46.45cm^2 95. 82 cm^2 96. 55 cm^2 97. 227cm^2

98. 308 cm^2 99. $149\frac{3}{16}\text{cm}^2$

100. Yes, It increases by 32 cm

101. 64 cm^2 102. perimeter = 26 cm, area = 24 cm^2

103. 205cm 104. 2.97cm^2 , ₹ 72.08 105. 28200m^2

106. ₹ 5400 107. ₹ 26400 108. 88cm, circle 109. 550 m

110. 31.43 m (app.), 75.43m^2 (app.), 111. 6.75m^2 , 13 : 27

112. (a) 188.68m^2 , (b) Rs 67776.80, (c) 62.6m (d) 251

113. (a) $(5x + 65)\text{m}^2$ (b) 44m (c) ₹ 250 ($x + 21$) including lobby between two bedrooms, ₹ 150 ($x + 35$) excluding lobby between two bedrooms.

(d) ₹ 150 ($15 - x$) (e) 7m

- 114.** 31.5m^2 **115.** 9086m^2 **116.** ₹ 1530 **117.** 1320cm^2
118. 1000cm^2 **119.** Area in both cases is 86 cm^2 **120.** 144
121. 57 m **122.** 35 cm^2 , 2.8 cm **123.** 108 **124.** 40 cm^2
125. (i) ₹ 4440 (ii) ₹ 69600 (iii) 22m^2 **126** (a) (i) 20.10m (ii) 22.68 m
 (iii) 21.78m (iv) 12.16m (v) 10.94m (b) ₹ 1848, ₹ 5929.36, ₹ 1478,
 ₹ 5737.86, ₹ 5008.52 (family room) (c) ₹ 43830
127. 2086 cm^2 **128.** 7550 cm^2 **129.** 7mm **130.** 2411520 km
131. ₹497.64

(D)

1. (i) 87.78 m (ii) 436.64 m^2 (iii) 10.50 m^2 (iv) 2.62 m^2 (v) 7.88m^2
 2. (i) 39 m (ii) 81.74 m^2 (iii) 12.238 m^2 (iv) 10.26 m^2
 3. (i) 32 m^2 (ii) 13050 m^2 (iii) 470 m
 4. (i) 1344.15 m^2 (ii) 293.2 m

5.	Radius	Diameter	Circumference
Foot ball	11.3 cm	22.6 cm	71 cm
Basket ball	12.4 cm	24.8 cm	77.872 cm
Cricket ball	3.66 cm	7.32 cm	23 cm
Volley ball	10.3 cm	20.6 cm	64.684 cm
Hockey ball	3.565 cm	7.13 cm	22.4 cm
Lawn Tennis ball	3.175 cm	6.35 cm	19.939 cm
Shot put	65 mm	130 mm	408.2 mm

6.

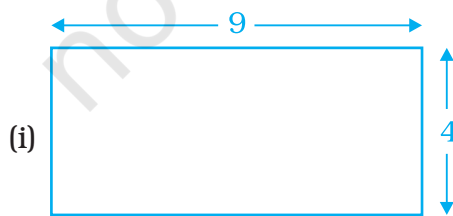

Area = 36
Perimeter = 26

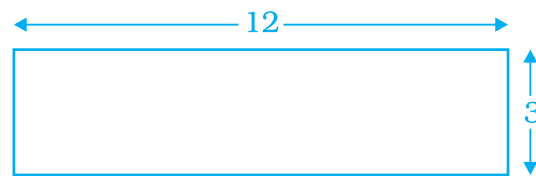

Area = 36
Perimeter = 30

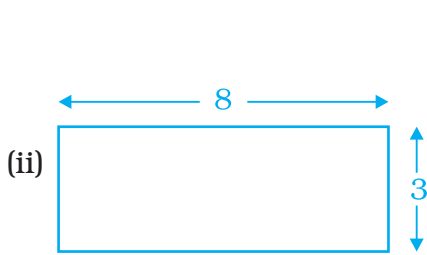

$$\text{Area} = 24$$
$$\text{Perimeter} = 22$$

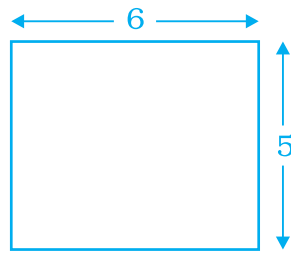

$$\text{Area} = 30$$
$$\text{Perimeter} = 22$$

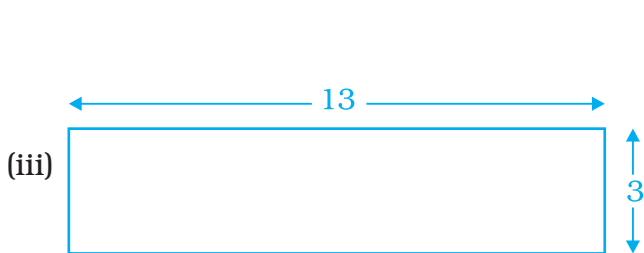

$$\text{Area} = 39$$
$$\text{Perimeter} = 32$$

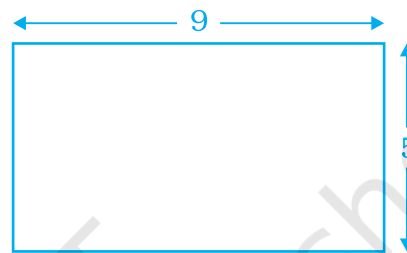

$$\text{Area} = 45$$
$$\text{Perimeter} = 28$$

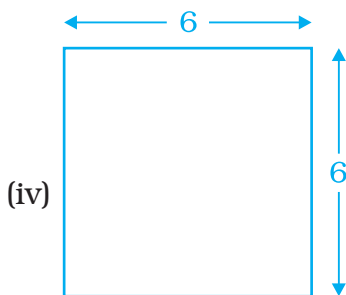

$$\text{Area} = 36$$
$$\text{Perimeter} = 24$$



$$\text{Area} = 12$$
$$\text{Perimeter} = 26$$

7.

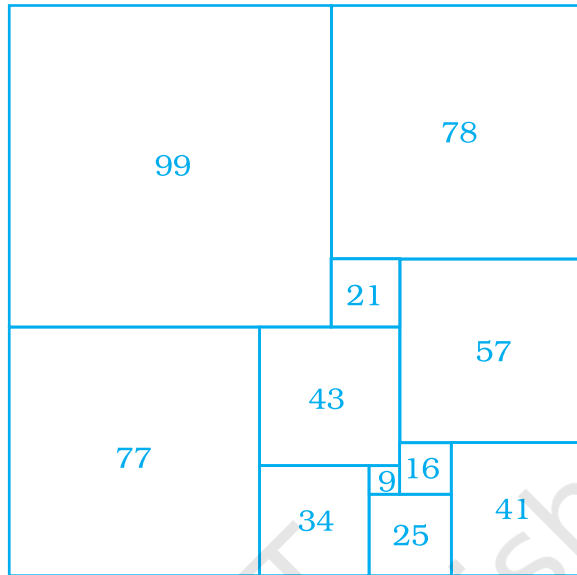

8. (i) Circumference (ii) Perimeter (iii) Area
 (iv) Parallelogram (v) Square (vi) Triangle
 (vii) One (viii) Diameter

Unit 10

1. (c) 2. (c) 3. (a) 4. (c) 5. (d) 6. (b)
 7. (d) 8. (a) 9. (c) 10. (a) 11. (c) 12. (a)
 13. (d) 14. (a) 15. (d) 16. (d) 17. a like term
 18. π 19. like 20. Unlike 21. r 22. one
 23. $n, 6n$ 24. constant 25. $55y$ 26. binomial 27. $2x^2$
 28. $b + c$ 29. $2y, 2y^2$ 30. $2x$ or $-4y^2$ or $-z$ 31. $-23x^2$
 32. $15xy$ 33. T 34. F 35. T 36. F 37. T

38. F 39. F 40. T 41. T 42. F 43. F

44. T 45. F 46. T 47. F 48. F 49. F

50. F 51. T 52. F 53. (a) $x^2 + xy$, Binomial

(b) $r - (3p \times 2q)$, Binomial (c) $p \times 2q \times 3r$, Monomial

(d) $ab + bc + ca$, Trinomial (e) $3x$, Monomial

(f) $2p + 2q$, Binomial (g) $\frac{1}{2}mn$, monomial

(h) x^2 , Monomial (i) $t^3 - s^3$, Binomial

(j) $(x \div 15)x$, Monomial or $\frac{x^2}{15}$ (k) $x^2 + z^3$, Binomial

(l) $q^3 - 2q$, Binomial 54. (i) 1, (ii) -2 (iii) 3 (iv) y^3

55. (i) 1, 1, -3, 5, -7 (ii) 10, -7, -9, 2, 2

56. (a) $4x^2yz^2 + 4xy^2z$ Binomial (b) $x^4 - 3xy^3 + y^4$ Trinomial

(c) $p^3q^2r + pq^2r^3 - 6p^2qr^2$ Trinomial (d) $2a - 2b + 2c$ Trinomial

(e) $60x^3 + 49x + 15$ Trinomial 57. (a) $-2p^2 - 9pq + 6q^2$

(b) $2x^3 - 3x^2y + 2xy^2 - y^3 + 4y$ (c) zero (d) $p^2 + q^2 + r^2$

(e) $x^3y^2 + 4x^2y^3 + x^4 + 7y^4$ (f) $p^2qr - 2pq^2r - pqr^2$ (g) zero

(h) $a^2 + b^2 + c^2 + 2ab + 2bc + 2ac$ (i) $p^5 + \frac{5}{8}p^4 - p^3 + \frac{25}{8}p^2 - 17p + \frac{31}{4}$

(j) $33t^3 - 6t^2 - 10t - 20$ 58. (a) $4p^2qr$ (b) $a^2 + b^2 + 2ab$

(c) $x^3 + y^3 + 3x^2y + 3xy^2$ (d) $x^4 - 4x^3y^3 + 2y^4$ (e) $-2ab + 2bc + 2ac$

(f) $a^2 + b^2 + 2ab$ (g) $x^4 + y^4 - x^3y^2 + 6xy^3$ (h) $-3ab - 3bc - 3ac$

(i) $-4.5x^5 + 5x^4 + 0.2x^2 - 7.3x - 5.7$ (j) $y^3 - y - 22$

- 59.** (a) $-3x^2y - 3xy^2$ (b) $-3p^2q^2 + pq$ **60.** (a) $x^3 - x^2y - xy^2 - y^3$
 (b) $m^2 + 2n^2 - 2mn$ **61.** $68a^3 - 47a^2 + 6a + 16$
- 62.** $y^4 - 17y^3 - 46y^2 + 52y - 54$ **63.** $-13p^3 + 98p^2 - 72p + 94$
- 64.** $-99x^3 + 33x^2 + 13x + 41$ **65.** $-9a^2 + 15a - 2$
- 66.** (A) 1 (B) 25 (C) 1 (D) -125 (E) $\frac{13}{3}$
 (F) $-\frac{5}{3}$ (G) $-\frac{13}{6}$ (H) 6 **67.** (A) 2 (B) 6 (C) 8 (D) -1
- (E) 14 (F) 9 **68.** (i) $4x^2 + 6x - 10$ (ii) $6x^2 - 6$
 (c) $12x^2 - 8x - 4$ **69.** $a = -2$ **70.** $-x^2$ **71.** $-3a^2 + 3b^2 - 20ab$
- 72.** $10x^2 - 8y^2 + x$ **73.** (a) $22y + 120$ (b) $8x + 14y$
- 74.** $y[x - \frac{1}{2}z]$ **75.** $\frac{3}{2}m^2$ **76.** $8x + 50$
- 77.** $350 + 50x$ or $50(x + 7)$ **78.** $9 + 3x$ **79.** $4x + 2y$ **80.** $\frac{1}{2}xyz$
- 81.** $14x + 2y$ **82.** ₹ $(10x + 20)$ **83.** (a) $4x + 1$ (b) $\frac{1}{3}(4x + 1)$
- 84.** $11xy^2$ **85.** (i) $18r + 6b = 6(3r + b)$, (ii) $6p + 6g$ $200(p + g)$
- 86.** (i) 15 (ii) 66 (iii) 410 **87.** 385
- 88.** (a) 385 (b) 550 (c) 1045
- 89.** (i) $8\frac{7}{2}$ (ii) 1 **90.** (i) $\frac{-9}{2}$ (ii) $\frac{303}{8}$
- 91.** Three subtracted from four times 'b'.
92. Eight times the sum of m and five.
93. Quotient on dividing seven by the difference of eight and x ($x < 8$).
94. Seventeen times quotient of sixteen by w.

95. (i) $\frac{1}{4}(x+7)$, $\frac{1}{4}(7+x)$ (ii) $\frac{n-5}{3}$

96. $2n+1$, yes 97. Less than 11

98. 1 → (e), 2 → (c), 3 → (d), 4 → (a), 5 → (g)
6 → (h), 7 → (f), 8 → (b)

99. Expression : $24 + 4(a - 2)$, 'a' stands for the present age of dog or cat

Age	$[24 + 4(a - 2)]$	Age (Human Years)
2	$24 + 4(2 - 2)$	24
3	$24 + 4(3 - 2)$	28
4	$24 + 4(4 - 2)$	32
5	$24 + 4(5 - 2)$	36
6	$24 + 4(6 - 2)$	40

100. (i) $x + y = y + x$, (ii) $x \times y = y \times x$,
(iii) $x + (y + z) = (x + y) + z$, (iv) $x \times (y \times z) = (x \times y) \times z$,
(v) $x \times (y + z) = x \times y + x \times z$

(D)

3.

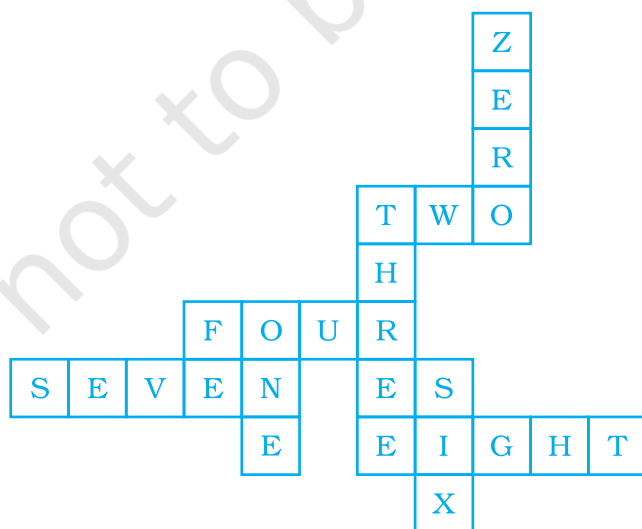

Unit 11

1. (b) 2. (b) 3. (c) 4. (c) 5. (c) 6. (c)
7. (c) 8. (d) 9. (c) 10. (b) 11. (c) 12. (d)
13. (c) 14. (c) 15. (d) 16. (c) 17. (d) 18. (d)
19. (c) 20. (c) 21. (c) 22. (b) 23. 44 24. 3
25. $\frac{11}{15}$ 26. 8 27. 12 28. 0 29. 32 30. $\frac{13}{14}$
31. 11 32. 5 33. 6 34. 6 35. 3 36. 5.37
37. 8.888 38. 7 39. 8 40. (a) < (b) < (c) > (d) < (e) <
41. False 42. True 43. False 44. False 45. True 46. True
47. False 48. True 49. False 50. False 51. False 52. False
53. True 54. True 55. True 56. False 57. False 58. False
59. False 60. True 61. True 62. False 63. False 64. True
65. False 66. Ascending order: $4^0, 2^3 \times 2, 2^3 \times 3^1, 3^3, 2^5, 3^5 (3^3)^2$
67. Descending order: $2^3 \times 5^2, (2^2)^3, 2^{2+3}, \frac{3^5}{3^2}, 3^2 \times 3^0, 2 \times 2^2$
68. $(-4)^2$ or 16 69. $m = 5$ 70. 729/64 71. $\frac{32}{27}$
72. (a) 1, (b) 1, (c) 1, (d) -3, (e) 24, (f) 0 73. $n = 0$
74. (a) 80100000 (b) 0.00175
75. (a) 32, (b) -243, (c) -256 76. (a) $27a^4 = 3^3a^4$ (b) $a^2b^3c^4$ (c) $S^4 \times t^3$
77. 30^6 78. (a) 2^{10} (b) 3×7^3 (c) $\frac{3^2 \times 2^4}{5^3 \times 7}$ 79. (a) 2^6 (b) 2^9 (c) 5.28×10^5
80. (a) $2^3 \times 3^2 \times 5^3$ (b) $3^4 \times 5^2$ (c) $2^5 \times 5^2$
81. (a) 6^3 (b) 4^4 (c) 35^2 (d) 5^6 (e) $(30)^3$ (f) $11^2 \times (-2)^5 = -3872$
82. (a) 7.647×10^6 (b) 8.19×10^7 (c) 5.83×10^{11} (d) 2.4×10^{10}
83. $1.44 \times 10^{11}m$

84. (a) $(3/7)^2$ (b) $\frac{7}{11}^5$ (c) 3^8
 (d) a^7 (e) $\frac{3}{5}^5$ (f) 5^{10}
85. (a) $49a^2b^3$ (b) 3920 (c) $\frac{25}{8}a^3$ (d) 729
 (e) $1/75$ (f) $6075/2$ (g) 1
86. Gibson, Australia; Thar, India; Great Victoria, Australia; Kalahari, South Africa; Sahara, North Africa.
87. Jupiter, Saturn, Neptune, Uranus, Earth, Venus, Mars, Mercury, Pluto.
88. (1) 6×10^1 (2) 3.6×10^3 (3) 8.64×10^4 (4) 2.6×10^6 (5) 3.2×10^7
 (6) 3.2×10^8
89. 12 : 5 90. $c = 3$ 91. (a) 9.46×10^{12} km, (b) less than
92. 9 93. 2^{18} 94. 3060 kg
95. Red blood cell has a greater diameter than a platelet.
96. (a) 1×10^{100} (b) 10^{200} 97. He has left power of 3 which is 5.

(D)**Down** 1.

2.

3.

4.

5.

Across 6.

7.

8.

9.

10.

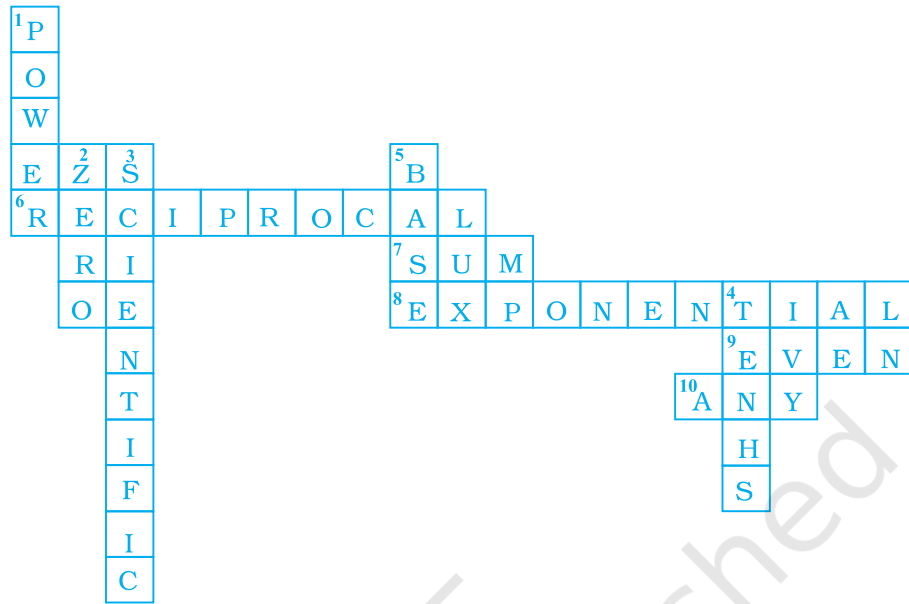

Activities 2

	¹	5	7	⁶	⁷
⁸	5		²	3	4
¹⁰	1	⁹	1		³
⁴	2	2	0		7
	1	⁵	1	0	0

Unit 12

1. (b) 2. (a) 3. (c) 4. (b) 5. (c) 6. (b)
 7. (b) 8. (c) 9. (d) 10. (c) 11. (b) 12. (c)
 13. (a) 14. (a) 15. (a) 16. (c) 17. (a) 18. (d)
 19. (b) 20. (c) 21. (c) 22. (c) 23. (a) 24. (b)
 25. (c) 26. (b) 27. (a) 28. (c) 29. one 30. 2,2
 31. Isosceles 32. Quadrilateral 33. M and W 34. Edge
 35. Face 36. Vertices 37. Sphere 38. 5, 9, 6 39. 4, 6, 4
 40. 5, 8, 5 41. 5, 3, 2 42. Triangle 43. 5, 4, 1
 44. 5, 4, rectangle 45. 2 46. 2 47. Infinite
 48. Rectangle 49. Bisector 50. No 51. 8 52. Scalene
 53. Prism 54. 0, 0, 1 55. Cone 56. Triangle Prism
 57. 1 58. 10 59. False 60. True 61. False 62. False
 63. True 64. True 65. False 66. False 67. False 68. False
 69. False 70. False 71. True 72. True 73. False 74. True
 75. True 76. False 77. True 78. False 79. True 80. False
 81. True 82. False 83. False 84. True 85. False 86. True
 87. False 88. True 89. False 90. True 91. False 92. False
 93.

(i) Top Side view Front view

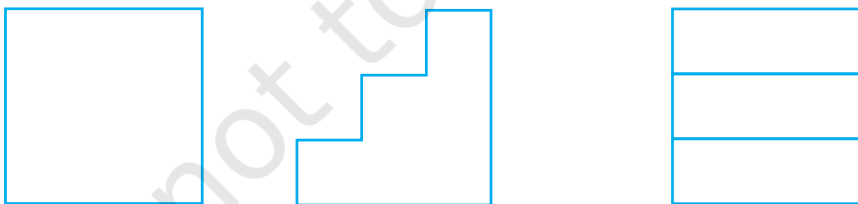

(ii) Top Side Front



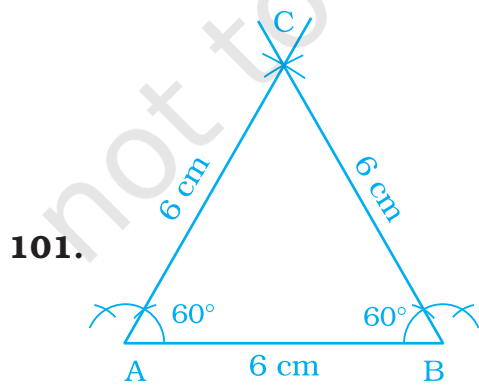
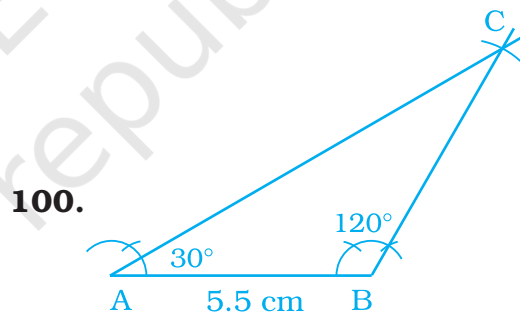
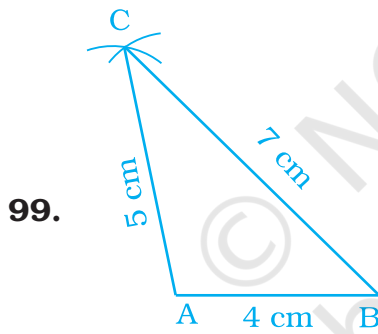
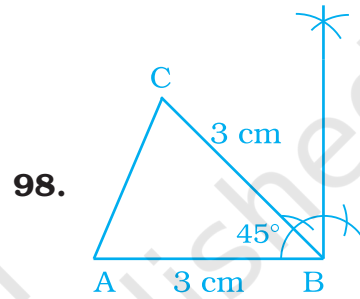
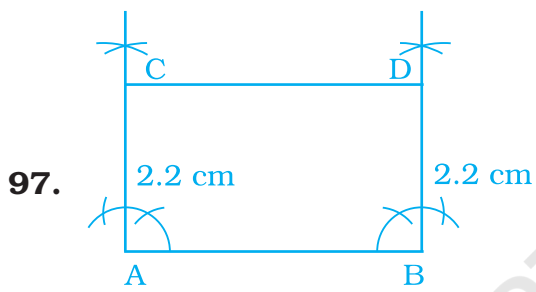
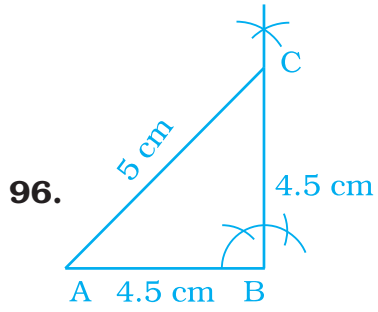
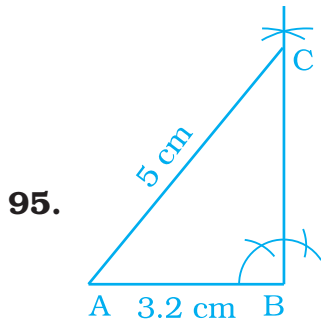

102. 60°

103.

Figure	Number of Lines of Symmetry	Order of Rotation of Symmetry
a	1	1
b	1	1
c	1	1
d	2	2
e	1	2
f	0	1
g	1	1
h	0	3
i	4	4
j	1	1
k	0	1
l	1	1
m	0	2
n	0	1
o	1	1
p	1	1
q	1	1
r	0	3
s	3	3
t	1	1
u	10	10
v	3	3
w	0	1

104. (i) EF (ii) ABFE, BFGC (iii) ABEF, ABCD, ADHE

(iv) D (v) CD, EF, GH (vi) AE, EF, GH, HD

(vii) AE, BF, AD, BC (viii) Several group of points like - A, E, C, B

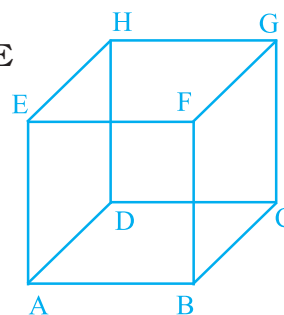

105.

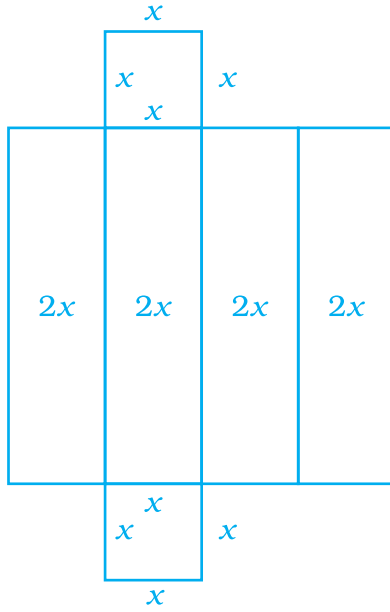

106.

(i) Triangle prism

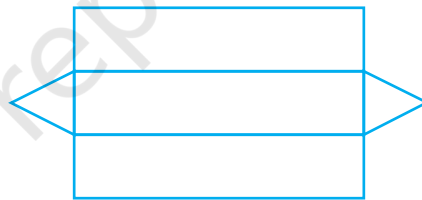

(ii)

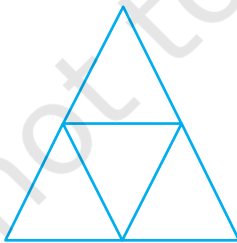

(iii)

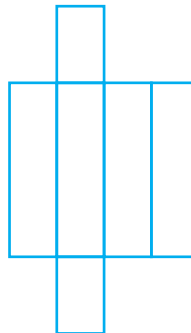

107.

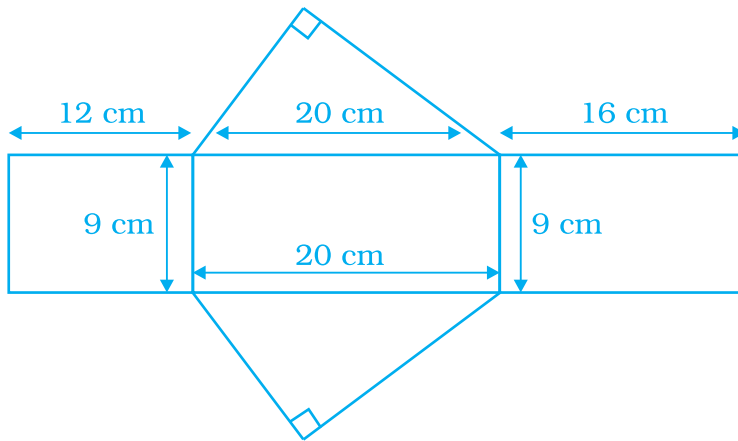

109.

(i) HG (ii) CD

110.

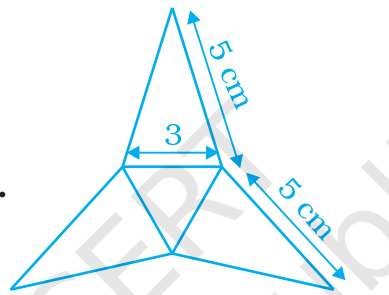

111.

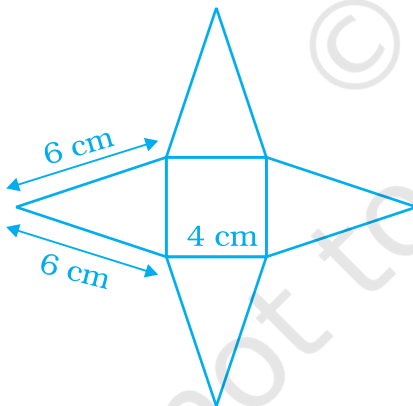

112.

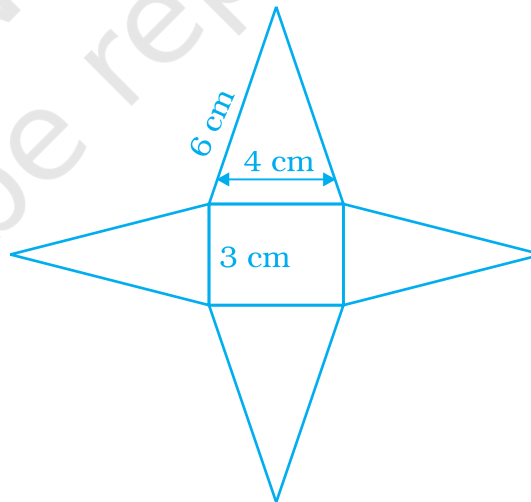

113. (a) 6 (b) 8 (c) 7 (d) 8 (e) 6 (f) 8 (g) 6 (h) 8

114.

(a)

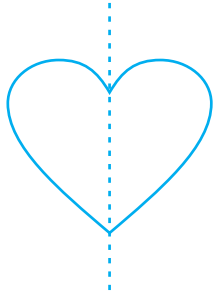

One line of symmetry

(b)



No line of symmetry

(c)

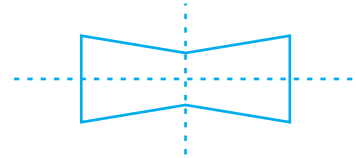

Two line symmetry

115. 16

116.

(a)

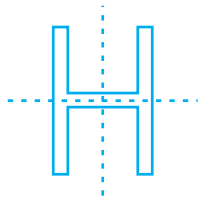

2 lines of symmetry

(b)



No line of symmetry

(c)

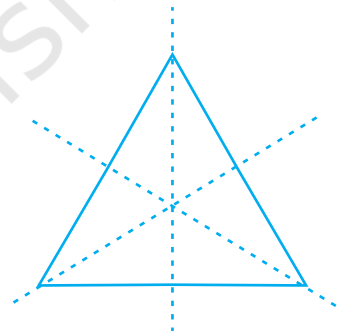

3 lines of symmetry

117.

(a) Yes

(d) Yes

(b) No

(e) Yes

(c) Yes

(f) Yes

118.

(a)

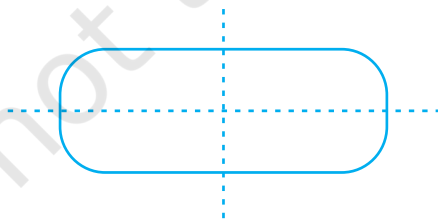

(b)

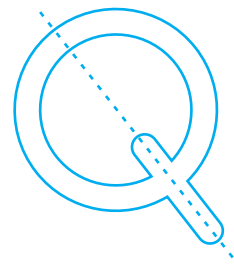

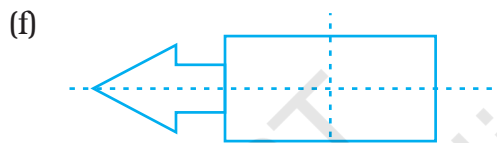
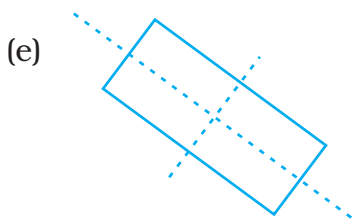
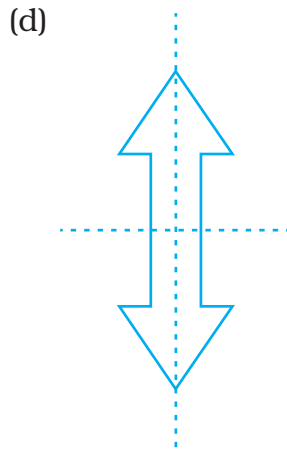
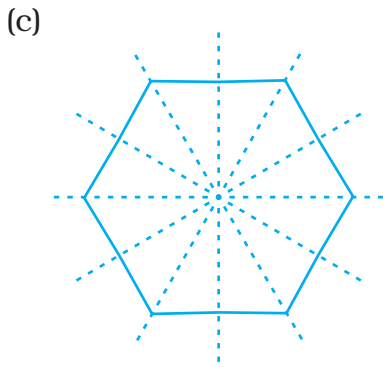

119. (a) Yes (b) Yes (c) No (d) Yes

120. No

121. 2

122. (a) and (c)

123. d

Extra Question:-

Write the name 5 letter of English alphabet which have no line of symmetry

124. F, G, J, L, N, P, Q, R, S, Z,

(D)

Across

1. ISOMETRIC
3. PARALLEL
5. CONE
7. CIRCLE
9. TRIANGULAR PRISM

Down

2. CENTRE OF ROTATION
4. SPHERE
6. EDGE
8. NET
10. SQUARE

© NCERT
not to be republished