

## ANSWERS

### Chapter 2

- 2.1 (b)  
2.2 (b)  
2.3 (c)  
2.4 (d)  
2.5 (a)  
2.6 (c)  
2.7 (a)  
2.8 (d)  
2.9 (a)  
2.10 (a)  
2.11 (c)  
2.12 (d)  
2.13 (b), (c)  
2.14 (a), (e)  
2.15 (b), (d)  
2.16 (a), (b), (d)  
2.17 (a), (b)  
2.18 (b), (d)  
2.19 Because, bodies differ in order of magnitude significantly in respect to the same physical quantity. For example, interatomic distances are of the order of angstroms, inter-city distances are of the order of km, and interstellar distances are of the order of light year.

2.20  $10^{15}$

2.21 Mass spectrograph

2.22  $1 \text{ u} = 1.67 \times 10^{-27} \text{ kg}$

2.23 Since  $f(\theta)$  is a sum of different powers of  $\theta$ , it has to be dimensionless

2.24 Because all other quantities of mechanics can be expressed in terms of length, mass and time through simple relations.

2.25 (a)  $\theta = \frac{R_E}{60R_E} = \frac{1}{60} \text{ rad} \approx 1^\circ$

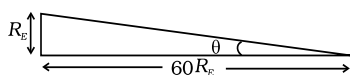

$\therefore$  Diameter of the earth as seen from the moon is about  $2^\circ$ .

(b) At earth-moon distance, moon is seen as  $(1/2)^\circ$  diameter and earth is seen as  $2^\circ$  diameter. Hence, diameter of earth is 4 times the diameter of moon.

$$\frac{D_{\text{earth}}}{D_{\text{moon}}} = 4$$

(c)  $\frac{r_{\text{sun}}}{r_{\text{moon}}} = 400$

(Here  $r$  stands for distance, and  $D$  for diameter.)

Sun and moon both appear to be of the same angular diameter as seen from the earth.

$$\therefore \frac{D_{\text{sun}}}{r_{\text{sun}}} = \frac{D_{\text{moon}}}{r_{\text{moon}}}$$

$$\therefore \frac{D_{\text{sun}}}{D_{\text{moon}}} = 400$$

$$\text{But } \frac{D_{\text{earth}}}{D_{\text{moon}}} = 4 \quad \therefore \frac{D_{\text{sun}}}{D_{\text{earth}}} = 100$$

2.26 An atomic clock is the most precise time measuring device because atomic oscillations are repeated with a precision of  $1\text{s}$  in  $10^{13} \text{ s}$ .

2.27  $3 \times 10^{16} \text{ s}$

2.28  $0.01 \text{ mm}$

2.29  $\theta = (\pi R_s^2 / R_{es}^2)(\pi R_m^2 / R_{em}^2)$

$$\Rightarrow \frac{R_s}{R_m} = \frac{R_{es}}{R_{em}}$$

2.30  $10^5 \text{ kg}$

- 2.31 (a) Angle or solid angle  
 (b) Relative density, etc.  
 (c) Planck's constant, universal gravitational constant, etc.  
 (d) Raynold number

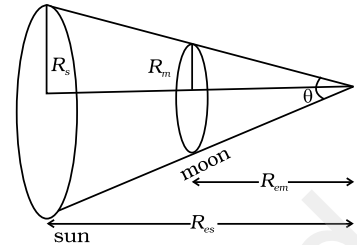

2.32  $\theta = \frac{l}{r} \Rightarrow l = r\theta \Rightarrow l = 31 \times \frac{3.14}{6} \text{ cm} = 16.3 \text{ cm}$

2.33  $4 \times 10^{-2}$  steradian

2.34 Dimensional formula of  $\omega = T^{-1}$   
 Dimensional formula of  $k = L^{-1}$

- 2.35 (a) Precision is given by the least count of the instrument.

For 20 oscillations, precision = 0.1 s

For 1 oscillation, precision = 0.005 s.

(b) Average time  $t = \frac{39.6 + 39.9 + 39.5}{3} \text{ s} = 39.6 \text{ s}$

Period =  $\frac{39.6}{20} = 1.98 \text{ s}$

Max. observed error =  $(1.995 - 1.980) \text{ s} = 0.015 \text{ s}$ .

- 2.36 Since energy has dimensions of  $ML^2 T^{-2}$ , 1J in new units becomes  $\gamma^2 / \alpha\beta^2 \text{ J}$ . Hence 5 J becomes  $5\gamma^2 / \alpha\beta^2$ .

- 2.37 The dimensional part in the expression is  $\frac{\rho r^4}{\eta l}$ . Therefore, the dimensions of the right hand side comes out to be

$$\frac{[ML^{-1}T^{-2}][L^4]}{[ML^{-1}T^{-1}][L]} = \frac{[L^3]}{[T]}$$

which is volume upon time. Hence, the formula is dimensionally correct.

- 2.38 The fractional error in X is

$$\frac{dX}{X} = \frac{2da}{a} + \frac{3db}{b} + \frac{2.5dc}{c} + \frac{2d(d)}{d}$$

$$= 0.235 = 0.24$$

Since the error is in first decimal, hence the result should be rounded off as 2.8.

**2.39** Since E,  $l$  and G have dimensional formulas:

$$E \rightarrow ML^2T^{-2}$$

$$l \rightarrow ML^2T^{-1}$$

$$G \rightarrow L^3M^{-1}T^{-2}$$

Hence,  $P = E l^2 m^{-5} G^{-2}$  will have dimensions:

$$\begin{aligned} [P] &= \frac{[ML^2T^{-2}][M^2L^4T^{-2}][M^2T^4]}{[M^5][L^6]} \\ &= M^0L^0T^0 \end{aligned}$$

Thus, P is dimensionless.

**2.40** M, L, T, in terms of new units become

$$M \rightarrow \sqrt{\frac{ch}{G}}, L \rightarrow \sqrt{\frac{hG}{c^3}}, T \rightarrow \sqrt{\frac{hG}{c^5}}$$

**2.41** Given  $T^2 \propto r^3 \Rightarrow T \propto r^{3/2}$ . T is also function of  $g$  and

$$R \Rightarrow T \propto g^x R^y$$

$$\therefore [L^0M^0T^1] = [L^{3/2}M^0T^0][L^1M^0T^{-2}]^x [L^1M^0T^0]^y$$

$$\text{For L, } 0 = \frac{3}{2} + x + y$$

$$\text{For T, } 1 = 0 - 2x \Rightarrow x = -\frac{1}{2}$$

$$\text{Therefore, } 0 = \frac{3}{2} - \frac{1}{2} + y \Rightarrow y = -1$$

$$\text{Thus, } T = kr^{3/2}g^{-1/2}R^{-1} = \frac{k}{R}\sqrt{\frac{r^3}{g}}$$

**2.42** (a) Because oleic acid dissolves in alcohol but does not dissolve in water.

(b) When lycopodium powder is spread on water, it spreads on the entire surface. When a drop of the prepared solution is dropped on water, oleic acid does not dissolve in water, it spreads on the water surface pushing the lycopodium powder away to clear a circular area where the drop falls. This allows measuring the area where oleic acid spreads.

- (c)  $\frac{1}{20} \text{ mL} \times \frac{1}{20} = \frac{1}{400} \text{ mL}$
- (d) By means of a burette and measuring cylinder and measuring the number of drops.
- (e) If  $n$  drops of the solution make 1 mL, the volume of oleic acid in one drop will be  $(1/400)n$  mL.

**2.43** (a) By definition of parsec

$$\therefore 1 \text{ parsec} = \left( \frac{1 \text{ A.U.}}{1 \text{ arc sec}} \right)$$

$$1 \text{ deg} = 3600 \text{ arc sec}$$

$$\therefore 1 \text{ arcsec} = \frac{\pi}{3600 \times 180} \text{ radians}$$

$$\therefore 1 \text{ parsec} = \frac{3600 \times 180}{\pi} \text{ A.U.} = 206265 \text{ A.U.} \approx 2 \times 10^5 \text{ A.U.}$$

(b) At 1 A.U. distance, sun is  $(1/2^\circ)$  in diameter.

Therefore, at 1 parsec, star is  $\frac{1/2}{2 \times 10^5}$  degree in diameter =  $15 \times 10^{-5}$  arcmin.

With 100 magnification, it should look  $15 \times 10^{-3}$  arcmin. However, due to atmospheric fluctuations, it will still look of about 1 arcmin.

It can't be magnified using telescope.

$$(c) \frac{D_{\text{mars}}}{D_{\text{earth}}} = \frac{1}{2}, \quad \frac{D_{\text{earth}}}{D_{\text{sun}}} = \frac{1}{400} \text{ [from Answer 2.25 (c)]}$$

$$\therefore \frac{D_{\text{mars}}}{D_{\text{sun}}} = \frac{1}{800}$$

At 1 A.U. sun is seen as  $1/2$  degree in diameter, and mars will be seen as  $1/1600$  degree in diameter.

At  $1/2$  A.U, mars will be seen as  $1/800$  degree in diameter. With 100 magnification mars will be seen as  $1/8$  degree =  $\frac{60}{8} = 7.5$  arcmin.

This is larger than resolution limit due to atmospheric fluctuations. Hence, it looks magnified.

**2.44** (a) Since  $1 \text{ u} = 1.67 \times 10^{-27} \text{ kg}$ , its energy equivalent is  $1.67 \times 10^{-27} c^2$  in SI units. When converted to eV and MeV, it turns out to be  $1 \text{ u} \equiv 931.5 \text{ MeV}$ .

(b)  $1 \text{ u} \times c^2 = 931.5 \text{ MeV}$ .

Chapter 3

- 3.1 (b)
- 3.2 (a)
- 3.3 (b)
- 3.4 (c)
- 3.5 (b)
- 3.6 (c)
- 3.7 (a), (c), (d)
- 3.8 (a), (c), (e)
- 3.9 (a), (d)
- 3.10 (a), (c)
- 3.11 (b), (c), (d)
- 3.12 (a) (iii), (b) (ii), (c) iv, (d) (i)

3.13

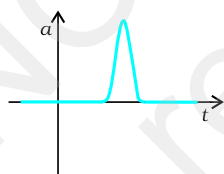

- 3.14 (i)  $x(t) = t - \sin t$
- (ii)  $x(t) = \sin t$

3.15  $x(t) = A + B e^{-\gamma t}$ ;  $A > B$ ,  $\gamma > 0$  are suitably chosen positive constants.

3.16  $v = g/b$

3.17 The ball is released and is falling under gravity. Acceleration is  $-g$ , except for the short time intervals in which the ball collides with

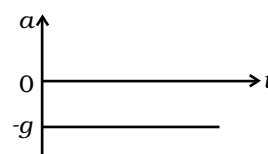
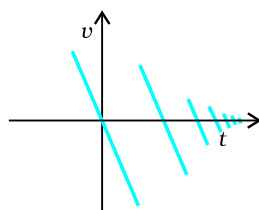

ground, and when the impulsive force acts and produces a large acceleration.

3.18 (a)  $x = 0, v = \gamma x_0$

3.19 Relative speed of cars = 45 km/h, time required to meet  
 $= \frac{36 \text{ km}}{45 \text{ km/h}} = 0.80 \text{ h}$

Thus, distance covered by the bird = 36 km/h  $\times$  0.8h = 28.8 km.

3.20 Suppose that the fall of 9 m will take time  $t$ . Hence

$$y - y_0 = v_{oy}t - \frac{gt^2}{2}$$

Since  $v_{oy} = 0$ ,

$$t = \sqrt{\frac{2(y - y_0)}{g}} \rightarrow \sqrt{\frac{2 \times 9 \text{ m}}{10 \text{ m/s}^2}} = \sqrt{1.8} \approx 1.34 \text{ seconds.}$$

In this time, the distance moved horizontally is

$$x - x_0 = v_{ox}t = 9 \text{ m/s} \times 1.34 \text{ s} = 12.06 \text{ m.}$$

Yes-he will land.

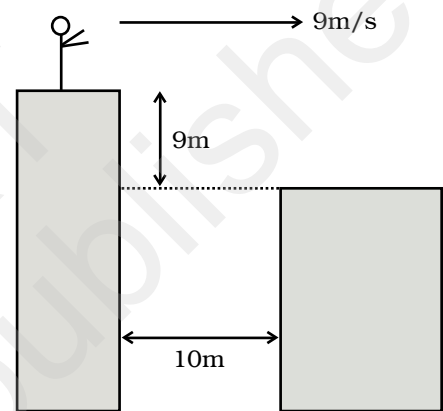

3.21 Both are free falling. Hence, there is no acceleration of one w.r.t. another. Therefore, relative speed remains constant (=40 m/s ).

3.22  $v = (-v_0/x_0) x + v_0, a = (v_0/x_0)^2 x - v_0^2/x_0$

The variation of  $a$  with  $x$  is shown in the figure. It is a straight line with a positive slope and a negative intercept.

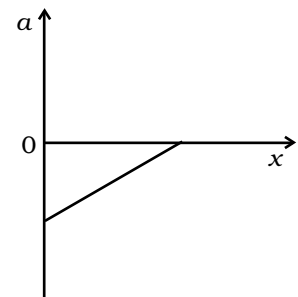

3.23 (a)  $v = \sqrt{2gh} = \sqrt{2 \times 10 \times 1000} = 141 \text{ m/s} = 510 \text{ km/h.}$

(b)  $m = \frac{4\pi}{3} r^3 \rho = \frac{4\pi}{3} (2 \times 10^{-3})^3 (10^3) = 3.4 \times 10^{-5} \text{ kg.}$

$$P = mv \approx 4.7 \times 10^{-3} \text{ kg m/s} \approx 5 \times 10^{-3} \text{ kg m/s.}$$

(c) Diameter  $\approx 4 \text{ mm}$

$$\Delta t \approx d / v = 28 \mu\text{s} \approx 30 \mu\text{s}$$

(d)  $F = \frac{\Delta P}{\Delta t} = \frac{4.7 \times 10^{-3}}{28 \times 10^{-6}} \approx 168 \text{ N} \approx 1.7 \times 10^2 \text{ N.}$

(e) Area of cross-section =  $\pi d^2 / 4 \approx 0.8 \text{ m}^2.$

With average separation of 5 cm, no. of drops that will fall almost simultaneously is  $\frac{0.8\text{m}^2}{(5 \times 10^{-2})^2} \approx 320$ .

Net force  $\approx 54000$  N (Practically drops are damped by air viscosity).

### 3.24 Car behind the truck

$$\text{Regardation of truck} = \frac{20}{5} = 4\text{ms}^{-2}$$

$$\text{Regardation of car} = \frac{20}{3}\text{ms}^{-2}$$

Let the truck be at a distance  $x$  from the car when breaks are applied

$$\text{Distance of truck from A at } t > 0.5 \text{ s is } x + 20t - 2t^2.$$

$$\text{Distance of car from A is } 10 + 20(t - 0.5) - \frac{10}{3}(t - 0.5)^2.$$

If the two meet

$$x + 20t - 2t^2 = 10 + 20t - 10 - \frac{10}{3}t^2 + \frac{10}{3}t - 0.25 \times \frac{10}{3}.$$

$$x = -\frac{4}{3}t^2 + \frac{10}{3}t - \frac{5}{6}.$$

To find  $x_{\min}$ ,

$$\frac{dx}{dt} = -\frac{8}{3}t + \frac{10}{3} = 0$$

$$\text{which gives } t_{\min} = \frac{10}{8} = \frac{5}{4} \text{ s.}$$

$$\text{Therefore, } x_{\min} = -\frac{4}{3}\left(\frac{5}{4}\right)^2 + \frac{10}{3} \times \frac{5}{4} - \frac{5}{6} = \frac{5}{4}.$$

Therefore,  $x > 1.25\text{m}$ .

**Second method:** This method does not require the use of calculus.

If the car is behind the truck,

$$V_{\text{car}} = 20 - (20/3)(t - 0.5) \text{ for } t > 0.5 \text{ s as car decelerate only after 0.5 s.}$$

$$V_{\text{truck}} = 20 - 4t$$

Find  $t$  from equating the two or from velocity vs time graph. This yields  $t = 5/4$  s.

In this time truck would travel truck,

$$S_{\text{truck}} = 20(5/4) - (1/2)(4)(5/4)^2 = 21.875\text{m}$$



and car would travel,  $S_{\text{car}} = 20(0.5) + 20(5/4 - 0.5) -$

$$\left(\frac{1}{2}\right)(20/3) \times \left(\frac{5}{4} - 0.5\right)^2 = 23.125\text{m}$$

Thus  $S_{\text{car}} - S_{\text{truck}} = 1.25\text{m}$ .

If the car maintains this distance initially, its speed after 1.25s will be always less than that of truck and hence collision never occurs.

**3.25** (a)  $(3/2)\text{s}$ , (b)  $(9/4)\text{s}$ , (c)  $0.3\text{s}$ , (d) 6 cycles.

**3.26**  $v_1 = 20\text{ m/s}$ ,  $v_2 = 10\text{ m/s}$ , time difference = 1s.

## Chapter 4

**4.1** (b)

**4.2** (d)

**4.3** (b)

**4.4** (b)

**4.5** (c)

**4.6** (b)

**4.7** (d)

**4.8** (c)

**4.9** (c)

**4.10** (b)

**4.11** (a), (b)

**4.12** (c)

**4.13** (a), (c)

**4.14** (a), (b), (c)

**4.15** (b), (d)

**4.16**  $\frac{v^2}{R}$  in the direction **RO**.

**4.17** The students may discuss with their teachers and find answer.

**4.18** (a) Just before it hits the ground.

- (b) At the highest point reached.  
 (c)  $a = g = \text{constant}$ .

**4.19** acceleration –  $g$ .  
 velocity – zero.

**4.20** Since  $\mathbf{B} \times \mathbf{C}$  is perpendicular to plane of  $\mathbf{B}$  and  $\mathbf{C}$ , cross product of any vector will lie in the plane of  $\mathbf{B}$  and  $\mathbf{C}$ .

**4.21**

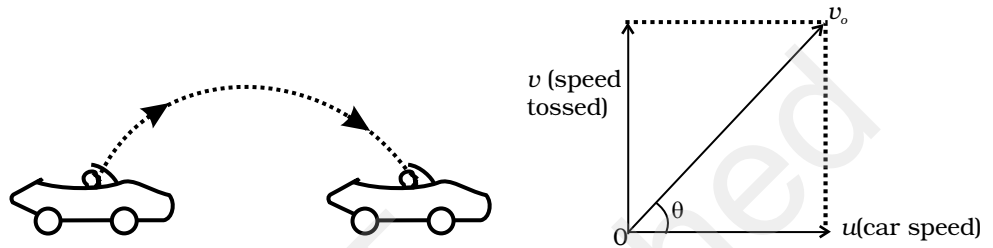

For a ground-based observer, the ball is a projectile with speed  $v_0$  and the angle of projection  $\theta$  with horizontal in as shown above.

**4.22**

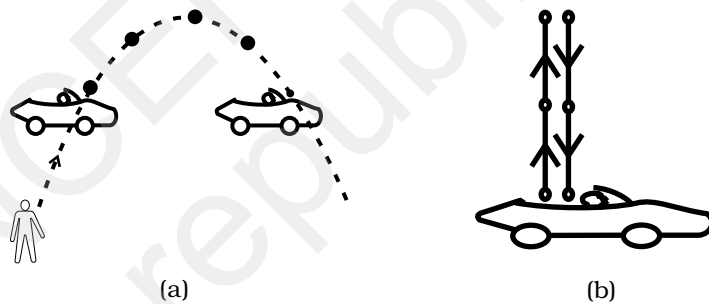

Since the speed of car matches with the horizontal speed of the projectile, boy sitting in the car will see only vertical component of motion as shown in Fig (b).

**4.23** Due to air resistance, particle energy as well as horizontal component of velocity keep on decreasing making the fall steeper than rise as shown in the figure.

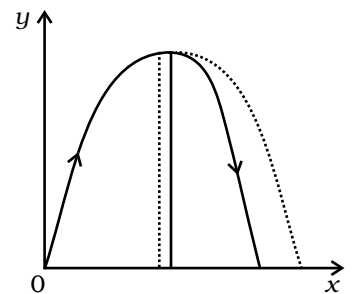

**4.24**  $R = v_0 \sqrt{\frac{2H}{g}}, \phi = \tan^{-1} \left( \frac{H}{R} \right) = \tan^{-1} \left( \frac{1}{v_0} \sqrt{\frac{gH}{2}} \right) = 23^\circ 12'$

**4.25** Acceleration  $\frac{v^2}{R} = \frac{4\pi^2 R}{T^2}$

- 4.26** (a) matches with (iv)  
 (b) matches with (iii)  
 (c) matches with (i)  
 (d) matches with (ii)

- 4.27** (a) matches with (ii)  
 (b) matches with (i)  
 (c) matches with (iv)  
 (d) matches with (iii)

- 4.28** (a) matches with (iv)  
 (b) matches with (iii)  
 (c) matches with (i)  
 (d) matches with (ii)

- 4.29** The minimum vertical velocity required for crossing the hill is given by

$$v_{\perp}^2 \geq 2gh = 10,000$$

$$v_{\perp} > 100 \text{ m/s}$$

As canon can haul packets with a speed of 125m/s, so the maximum value of horizontal velocity,  $v_{\parallel}$  will be

$$v_{\parallel} = \sqrt{125^2 - 100^2} = 75 \text{ m/s}$$

The time taken to reach the top of the hill with velocity  $v_{\perp}$  is given by

$$\frac{1}{2} gT^2 = h \Rightarrow T = 10 \text{ s.}$$

In 10s the horizontal distance covered = 750 m.

So cannon has to be moved through a distance of 50 m on the ground.

So total time taken (shortest) by the packet to reach ground

$$\text{across the hill} = \frac{50}{2} \text{ s} + 10\text{s} + 10\text{s} = 45 \text{ s.}$$

**4.31** (a)  $L = \frac{2v_o^2 \sin \beta \cos(\alpha + \beta)}{g \cos^2 \alpha}$

(b)  $T = \frac{2v_o \sin \beta}{g \cos \alpha}$

(c)  $\beta = \frac{\pi}{4} - \frac{\alpha}{2}$

**4.32**  $\frac{Av_o^2}{g} \sin \theta$

4.33  $\mathbf{V}_r = 5\hat{i} - 5\hat{j}$

4.34 (a) 5 m/s at  $37^\circ$  to N.

(b) (i)  $\tan^{-1}(3/\sqrt{7})$  of N, (ii)  $\sqrt{7}$  m/s

(c) in case (i) he reaches the opposite bank in shortest time.

4.35 (a)  $\tan^{-1}\left(\frac{v_o \sin \theta}{v_o \cos \theta + u}\right)$

(b)  $\frac{2v_o \sin \theta}{g}$

(c)  $R = \frac{2v_o \sin \theta (v_o \cos \theta + u)}{g}$

(d)  $\theta_{\max} = \cos^{-1}\left[\frac{-u + \sqrt{u^2 + 8v_o^2}}{4v_o}\right]$

(e)  $\theta_{\max} = 60^\circ$  for  $u = v_o$ .

$\theta_{\max} = 45^\circ$  for  $u = 0$ .

$u < v_o$

$\therefore \theta_{\max} \approx \cos^{-1}\left(\frac{1}{\sqrt{2}} - \frac{u}{4v_o}\right) = \pi/4$  (if  $u \ll v_o$ )

$u > v_o$   $\theta_{\max} \approx \cos^{-1}\left[\frac{v_o}{u}\right] = \pi/2$  ( $v_o \ll u$ )

(f)  $\theta_{\max} \geq 45^\circ$ .

4.36  $\mathbf{V} = \omega \hat{r} + \omega \theta \hat{\theta}$  and  $\mathbf{a} = \left(\frac{d^2\theta}{dt^2} - \omega^2 \theta\right) \hat{r} + \left(\theta \frac{d^2\theta}{dt^2} + 2\omega^2\right) \hat{\theta}$

4.37 Consider the straight line path APQC through the sand.

Time taken to go from A to C via this path

$$\begin{aligned} T_{\text{sand}} &= \frac{AP + QC}{1} + \frac{PQ}{v} \\ &= \frac{25\sqrt{2} + 25\sqrt{2}}{1} + \frac{50\sqrt{2}}{v} \\ &= 50\sqrt{2} \left[\frac{1}{v} + 1\right] \end{aligned}$$

The shortest path outside the sand will be ARC.

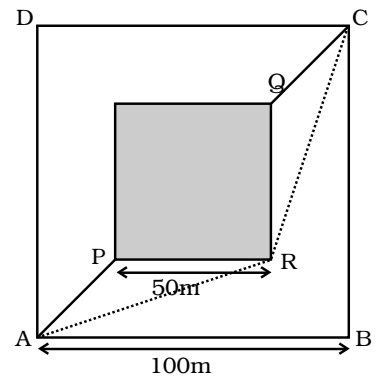

Time taken to go from A to C via this path

$$= T_{\text{outside}} = \frac{AR + RC}{1} \text{ s}$$

$$= 2\sqrt{75^2 + 25^2} \text{ s}$$

$$= 2 \times 25\sqrt{10} \text{ s}$$

$$\text{For } T_{\text{sand}} < T_{\text{outside}}, \quad 50\sqrt{2} \left[ \frac{1}{v} + 1 \right] < 2 \times 25\sqrt{10}$$

$$\Rightarrow \frac{1}{v} + 1 < \sqrt{5}$$

$$\Rightarrow \frac{1}{v} < \sqrt{5} - 1 \text{ or } v > \frac{1}{\sqrt{5} - 1} \approx 0.81 \text{ m/s.}$$

## Chapter 5

- 5.1 (c)  
 5.2 (b)  
 5.3 (c)  
 5.4 (c)  
 5.5 (d)  
 5.6 (c)  
 5.7 (a)  
 5.8 (b)  
 5.9 (b)  
 5.10 (a), (b) and (d)  
 5.11 (a), (b), (d) and (e)  
 5.12 (b) and (d)  
 5.13 (b), (c)  
 5.14 (c), (d)  
 5.15 (a), (c)  
 5.16 Yes, due to the principle of conservation of momentum.  
 Initial momentum =  $50.5 \times 5 \text{ kg m s}^{-1}$

$$\text{Final momentum} = (50 v + 0.5 \times 15) \text{ kg m s}^{-1}$$

$$v = 4.9 \text{ m s}^{-1}, \text{ change in speed} = 0.1 \text{ m s}^{-1}$$

**5.17** Let  $R$  be the reading of the scale, in newtons.

$$\text{Effective downward acceleration} = \frac{50g - R}{50} = g$$

$$R = 5g = 50\text{N. (The weighing scale will show 5 kg).}$$

**5.18** Zero;  $-\frac{3}{2} \text{ kg m s}^{-1}$

**5.19** The only retarding force that acts on him, if he is not using a seat belt comes from the friction exerted by the seat. This is not enough to prevent him from moving forward when the vehicle is brought to a sudden halt.

**5.20**  $\mathbf{p} = 8\hat{\mathbf{i}} + 8\hat{\mathbf{j}}$ ,  $\mathbf{F} = (4\hat{\mathbf{i}} + 8\hat{\mathbf{j}})\text{N}$

**5.21**  $f = F$  until the block is stationary.

$f$  remains constant if  $F$  increases beyond this point and the block starts moving.

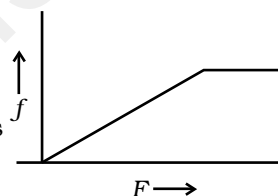

**5.22** In transportation, the vehicle say a truck, may need to halt suddenly. To bring a fragile material, like porcelain object to a sudden halt means applying a large force and this is likely to damage the object. If it is wrapped up in say, straw, the object can travel some distance as the straw is soft before coming to a halt. The force needed to achieve this is less, thus reducing the possibility of damage.

**5.23** The body of the child is brought to a sudden halt when she/he falls on a cement floor. The mud floor yields and the body travels some distance before it comes to rest, which takes some time. This means the force which brings the child to rest is less for the fall on a mud floor, as the change in momentum is brought about over a longer period.

**5.24** (a)  $12.5 \text{ N s}$  (b)  $18.75 \text{ kg m s}^{-1}$

**5.25**  $f = \mu R = \mu mg \cos\theta$  is the force of friction, if  $\theta$  is angle made by the slope. If  $\theta$  is small, force of friction is high and there is less chance of skidding. The road straight up would have a larger slope.

**5.26** AB, because force on the upper thread will be equal to sum of the weight of the body and the applied force.

**5.27** If the force is large and sudden, thread CD breaks because as CD is jerked, the pull is not transmitted to AB instantaneously (transmission depends on the elastic properties of the body). Therefore, before the mass moves, CD breaks.

**5.28**  $T_1 = 94.4 \text{ N}$ ,  $T_2 = 35.4 \text{ N}$

**5.29**  $W = 50 \text{ N}$

**5.30** If  $F$  is the force of the finger on the book,  $F = N$ , the normal reaction of the wall on the book. The minimum upward frictional force needed to ensure that the book does not fall is  $Mg$ . The frictional force  $= \mu N$ . Thus, minimum value of  $F = \frac{Mg}{\mu}$ .

**5.31**  $0.4 \text{ m s}^{-1}$

**5.32**  $x = t$ ,  $y = t^2$

$$a_x = 0, \quad a_y = 2 \text{ m s}^{-1}$$

$F = 0.5 \times 2 = 1 \text{ N}$ . along  $y$ -axis.

**5.33**  $t = \frac{2V}{g+a} = \frac{2 \times 20}{10+2} = \frac{40}{12} = \frac{10}{3} = 3.33 \text{ s}$ .

**5.34** (a) Since the body is moving with no acceleration, the sum of the forces is zero  $\mathbf{F}_1 + \mathbf{F}_2 + \mathbf{F}_3 = 0$ . Let  $\mathbf{F}_1, \mathbf{F}_2, \mathbf{F}_3$  be the three forces passing through a point. Let  $\mathbf{F}_1$  and  $\mathbf{F}_2$  be in the plane A (one can always draw a plane having two intersecting lines such that the two lines lie on the plane). Then  $\mathbf{F}_1 + \mathbf{F}_2$  must be in the plane A. Since  $\mathbf{F}_3 = -(\mathbf{F}_1 + \mathbf{F}_2)$ ,  $\mathbf{F}_3$  is also in the plane A.

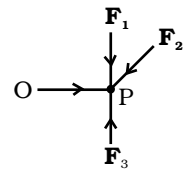

(b) Consider the torque of the forces about P. Since all the forces pass through P, the torque is zero. Now consider torque about another point O. Then torque about O is

$$\text{Torque} = \mathbf{OP} \times (\mathbf{F}_1 + \mathbf{F}_2 + \mathbf{F}_3)$$

Since  $\mathbf{F}_1 + \mathbf{F}_2 + \mathbf{F}_3 = 0$ , torque = 0

**5.35** **General case**

$$s = \frac{1}{2}at^2 \Rightarrow t = \sqrt{2s/a}$$

**Smooth case**

$$\text{Acceleration } a = g \sin \theta = \frac{g}{\sqrt{2}}$$

$$\therefore t_1 = \sqrt{2\sqrt{2}s/g}$$

**Rough case**

$$\begin{aligned} \text{Acceleration } a &= g \sin \theta - \mu g \cos \theta \\ &= (1 - \mu)g / \sqrt{2} \end{aligned}$$

$$\begin{aligned} \therefore t_2 &= \sqrt{\frac{2\sqrt{2}s}{(1-\mu)g}} = pt_1 = p\sqrt{\frac{2\sqrt{2}s}{g}} \\ \Rightarrow \frac{1}{1-\mu} &= p^2 \Rightarrow \mu = 1 - \frac{1}{p^2} \end{aligned}$$

**5.36**

$$\begin{aligned} v_x &= 2t & 0 < t \leq 1 & & v_y &= t & 0 < t < 1\text{s} \\ &= 2(2-t) & 1 < t < 2 & & &= 11 < t \\ &= 0 & 2 < t & & & \\ F_x &= 2; & 0 < t < 1 & & F_y &= 1 & 0 < t < 1\text{s} \\ &= -2; & 1\text{s} < t < 2\text{s} & & &= 0 & 1\text{s} < t \\ &= 0; & 2\text{s} < t & & & \\ \mathbf{F} &= 2\hat{\mathbf{i}} + \hat{\mathbf{j}} & 0 < t < 1\text{s} & & & \\ &= -2\hat{\mathbf{i}} & 1\text{s} < t < 2\text{s} & & & \\ &= 0 & 2\text{s} < t & & & \end{aligned}$$

**5.37** For DEF

$$\begin{aligned} \mu \frac{v^2}{R} &= \mu g \\ v_{\max} &= \sqrt{g\mu R} = \sqrt{100} = 10 \text{ m s}^{-1} \end{aligned}$$

For ABC

$$\frac{v^2}{2R} = g\mu, v = \sqrt{200} = 14.14 \text{ m s}^{-1}$$

$$\text{Time for DEF} = \frac{\pi}{2} \times \frac{100}{10} = 5\pi \text{ s}$$

$$\text{Time for ABC} = \frac{3\pi}{2} \frac{200}{14.14} = \frac{300\pi}{14.14} \text{ s}$$

$$\text{For FA and DC} = 2 \times \frac{100}{50} = 4 \text{ s}$$

$$\text{Total time} = 5\pi + \frac{300\pi}{14.14} + 4 = 86.3 \text{ s}$$

**5.38**

$$\frac{d\mathbf{r}}{dt} = \mathbf{v} = -\hat{\mathbf{i}} \omega A \sin \omega t + \hat{\mathbf{j}} \omega B \cos \omega t$$

$$\frac{d\mathbf{v}}{dt} = \mathbf{a} = -\omega^2 \mathbf{r}; \mathbf{F} = -m\omega^2 \mathbf{r}$$



$$x = A \cos \omega t, \quad y = B \sin \omega t \Rightarrow \frac{x^2}{A^2} + \frac{y^2}{B^2} = 1$$

5.39 For (a)  $\frac{1}{2}v_z^2 = gH \quad v_z = \sqrt{2gH}$

$$\text{Speed at ground} = \sqrt{v_s^2 + v_z^2} = \sqrt{v_s^2 + 2gH}$$

For (b) also  $\left[ \frac{1}{2}mv_s^2 + mgH \right]$  is the total energy of the ball when it hits the ground.

So the speed would be the same for both (a) and (b).

5.40  $F_2 = \frac{F_3 + F_4}{\sqrt{2}} = \frac{2+1}{\sqrt{2}} = \frac{3}{\sqrt{2}} \text{ N}$

$$F_1 + \frac{F_3}{\sqrt{2}} = \frac{F_4}{\sqrt{2}}$$

$$F_1 = \frac{F_4 - F_3}{\sqrt{2}} = \frac{1}{\sqrt{2}} \text{ N}$$

5.41 (a)  $\theta = \tan^{-1} \mu$

(b)  $mg \sin \alpha - \mu mg \cos \alpha$

(c)  $mg(\sin \alpha + \mu \cos \alpha)$

(d)  $mg(\sin \theta + \mu \cos \theta) + ma$ .

5.42 (a)  $F - (500 \times 10) = (500 \times 15)$  or  $F = 12.5 \times 10^3 \text{ N}$ , where  $F$  is the upward reaction of the floor and is equal to the force downwards on the floor, by Newton's 3rd law of motion

(b)  $R - (2500 \times 10) = (2500 \times 15)$  or  $R = 6.25 \times 10^4 \text{ N}$ , action of the air on the system, upwards. The action of the rotor on the surrounding air is  $6.25 \times 10^4 \text{ N}$  downwards.

(c) Force on the helicopter due to the air =  $6.25 \times 10^4 \text{ N}$  upwards.

Chapter 6

- 6.1 (b)
- 6.2 (c)
- 6.3 (d)
- 6.4 (c)
- 6.5 (c)
- 6.6 (c)
- 6.7 (c)
- 6.8 (b)
- 6.9 (b)
- 6.10 (b)
- 6.11 (b) as displacement  $\propto t^{3/2}$
- 6.12 (d)
- 6.13 (d)
- 6.14 (a)
- 6.15 (b)
- 6.16 (d)
- 6.17 (b)
- 6.18 (c)
- 6.19 (b), (d)
- 6.20 (b), (d), (f)
- 6.21 (c)
- 6.22 Yes, No.
- 6.23 To prevent elevator from falling freely under gravity.
- 6.24 (a) Positive, (b) Negative
- 6.25 Work done against gravity in moving along horizontal road is zero .
- 6.26 No, because resistive force of air also acts on the body which is a non-conservative force. So the gain in KE would be smaller than the loss in PE.
- 6.27 No, work done over each closed path is necessarily zero only if all the forces acting on the system are conservative.

6.28 (b) Total linear momentum.

While balls are in contact, there may be deformation which means elastic potential energy which came from part of KE. Momentum is always conserved.

6.29 
$$\text{Power} = \frac{mgh}{T} = \frac{100 \times 9.8 \times 10}{20} \text{ W} = 490 \text{ W}$$

6.30 
$$P = \frac{\Delta E}{\Delta t} = \frac{0.5 \times 72}{60} = 0.6 \text{ watts}$$

6.31 A charged particle moving in an uniform magnetic field.

6.32 Work done = change in KE

Both bodies had same KE and hence same amount of work is needed to be done. Since force applied is same, they would come to rest within the same distance.

6.33 (a) Straight line: vertical, downward

(b) Parabolic path with vertex at C.

(c) Parabolic path with vertex higher than C.

6.34

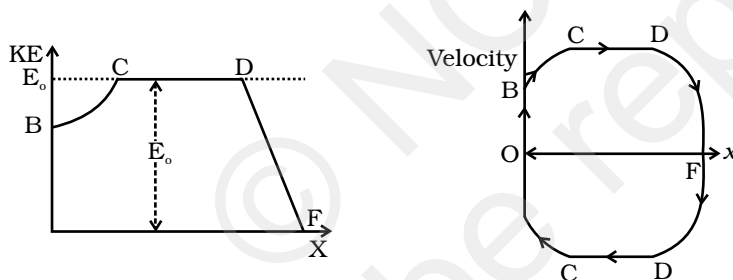

6.35 (a) For head on collision:

Conservation of momentum  $\Rightarrow 2mv_0 = mv_1 + mv_2$

Or  $2v_0 = v_1 + v_2$

and  $e = \frac{v_2 - v_1}{v_0} \Rightarrow v_2 = v_1 + 2v_0e$

$\therefore 2v_1 = 2v_0 - 2ev_0$

$\therefore v_1 = v_0(1 - e)$

Since  $e < 1 \Rightarrow v_1$  has the same sign as  $v_0$ , therefore the ball moves on after collision.

(b) Conservation of momentum  $\Rightarrow \mathbf{p} = \mathbf{p}_1 + \mathbf{p}_2$

But KE is lost  $\Rightarrow \frac{p^2}{2m} > \frac{p_1^2}{2m} + \frac{p_2^2}{2m}$

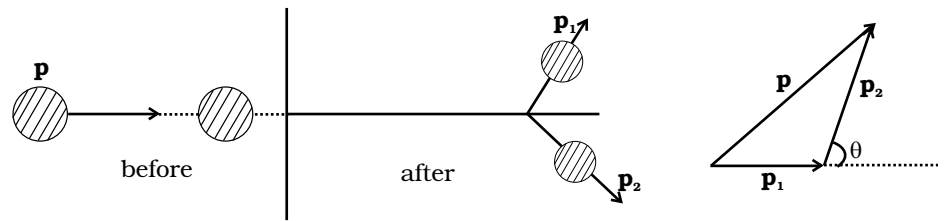

$$\therefore p^2 > p_1^2 + p_2^2$$

Thus  $\mathbf{p}$ ,  $\mathbf{p}_1$  and  $\mathbf{p}_2$  are related as shown in the figure.

$\theta$  is acute (less than  $90^\circ$ ) ( $p^2 = p_1^2 + p_2^2$  would give  $\theta = 90^\circ$ )

**6.36** Region A : No, as KE will become negative.

Region B : Yes, total energy can be greater than PE for non zero K.E.

Region C : Yes, KE can be greater than total energy if its PE is negative.

Region D : Yes, as PE can be greater than KE.

**6.37** (a) Ball A transfers its entire momentum to the ball on the table and does not rise at all.

(b)  $v = \sqrt{2gh} = 4.42 \text{ m/s}$

**6.38** (a) Loss of PE =  $mgh = 1 \times 10^{-3} \times 10 \times 10^{-3} = 10 \text{ J}$

(b) Gain in KE =  $\frac{1}{2}mv^2 = \frac{1}{2} \times 10^{-3} \times 2500 = 1.25 \text{ J}$

(c) No, because a part of PE is used up in doing work against the viscous drag of air.

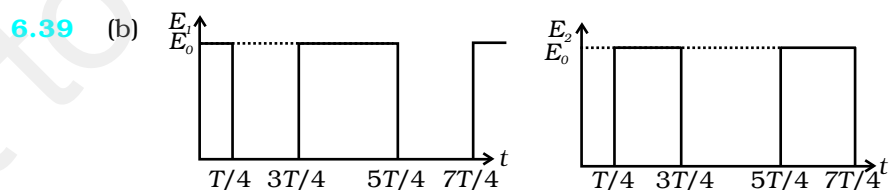

**6.40**  $m = 3.0 \times 10^{-5} \text{ kg}$   $\rho = 10^{-3} \text{ kg/m}^2$   $v = 9 \text{ m/s}$

$A = 1 \text{ m}^2$   $h = 100 \text{ cm} \Rightarrow n = 1 \text{ m}^3$

$M = \rho v = 10^{-3} \text{ kg}$ ,  $E = \frac{1}{2}Mv^2 = \frac{1}{2} \times 10^{-3} \times (9)^2 = 4.05 \times 10^{-4} \text{ J}$ .

$$6.41 \quad KE = \frac{1}{2}mv^2 \cong \frac{1}{2} \times 5 \times 10^4 \times 10^2 \\ = 2.5 \times 10^5 \text{ J.}$$

10% of this is stored in the spring.

$$\frac{1}{2}kx^2 = 2.5 \times 10^4$$

$$x = 1 \text{ m}$$

$$k = 5 \times 10^4 \text{ N/m.}$$

6.42 In 6 km there are 6000 steps.

$$\therefore E = 6000 (mgh) \\ = 6000 \times 600 \times 0.25 \\ = 9 \times 10^5 \text{ J.}$$

This is 10 % of intake.

$$\therefore \text{Intake energy} = 10 E = 9 \times 10^6 \text{ J.}$$

6.43 With 0.5 efficiency, 1 litre generates  $1.5 \times 10^7 \text{ J}$ , which is used for 15 km drive.

$$\therefore Fd = 1.5 \times 10^7 \text{ J. with } d = 15000 \text{ m}$$

$$\therefore F = 1000 \text{ N : force of friction.}$$

$$6.44 \quad (a) W_g = mg \sin \theta d = 1 \times 10 \times 0.5 \times 10 = 50 \text{ J.}$$

$$(b) W_f = \mu mg \cos \theta d = 0.1 \times 10 \times 0.866 \times 10 = 8.66 \text{ J.}$$

$$(c) \Delta U = mgh = 1 \times 10 \times 5 = 50 \text{ J}$$

$$(d) a = \{F - (mg \sin \theta + \mu mg \cos \theta)\} = [10 - 5.87]$$

$$= 4.13 \text{ m/s}^2$$

$$v = u + at \text{ or } v^2 = u^2 + 2ad$$

$$\Delta K = \frac{1}{2}mv^2 - \frac{1}{2}mu^2 = mad = 41.3 \text{ J}$$

$$(e) W = Fd = 100 \text{ J}$$

6.45 (a) Energy is conserved for balls 1 and 3.

(b) Ball 1 acquires rotational energy, ball 2 loses energy by friction.

They cannot cross at C. Ball 3 can cross over.

(c) Ball 1, 2 turn back before reaching C. Because of loss of energy, ball 2 cannot reach back to A. Ball 1 has a rotational motion in “wrong” sense when it reaches B. It cannot roll back to A, because of kinetic friction.

$$\begin{aligned}
 6.46 \quad (KE)_{t+\Delta t} &= \frac{1}{2}(M - \Delta m)(v + \Delta v)^2 + \frac{1}{2}\Delta m(v - u)^2 \\
 &= \frac{1}{2}Mv^2 + Mv\Delta v - \Delta mvu + \frac{1}{2}\Delta mu^2 \\
 (KE)_t &= \frac{1}{2}Mv^2
 \end{aligned}$$

$$(KE)_{t+\Delta t} - (KE)_t = (M\Delta v - \Delta mu)v + \frac{1}{2}\Delta mu^2 = \frac{1}{2}\Delta mu^2 = W$$

(By Work - Energy theorem)

$$\text{Since } \left( \frac{Mdv}{dt} = \left( \frac{dm}{dt} \right) (|u|) \right) \Rightarrow (M\Delta v - \Delta mu) = 0$$

$$6.47 \quad \text{Hooke's law : } \frac{F}{A} = Y \frac{\Delta L}{L}$$

where A is the surface area and L is length of the side of the cube. If k is spring or compression constant, then  $F = k \Delta L$

$$\therefore k = Y \frac{A}{L} = YL$$

$$\text{Initial KE} = 2 \times \frac{1}{2}mv^2 = 5 \times 10^{-4} \text{ J}$$

$$\text{Final PE} = 2 \times \frac{1}{2}k(\Delta L)^2$$

$$\therefore \Delta L = \sqrt{\frac{KE}{k}} = \sqrt{\frac{KE}{YL}} = \sqrt{\frac{5 \times 10^{-4}}{2 \times 10^{11} \times 0.1}} = 1.58 \times 10^{-7} \text{ m}$$

6.48 Let  $m$ ,  $V$ ,  $\rho_{He}$  denote respectively the mass, volume and density of helium balloon and  $\rho_{air}$  be density of air

Volume  $V$  of balloon displaces volume  $V$  of air.

$$\text{So, } V(\rho_{air} - \rho_{He})g = ma \quad (1)$$

Integrating with respect to  $t$ ,

$$V(\rho_{air} - \rho_{He})gt = mv$$

$$\Rightarrow \frac{1}{2}mv^2 = \frac{1}{2}m \frac{V^2}{m^2} (\rho_{air} - \rho_{He})^2 g^2 t^2 = \frac{1}{2m} V^2 (\rho_{air} - \rho_{He})^2 g^2 t^2 \quad (2)$$

If the balloon rises to a height  $h$ , from  $s = ut + \frac{1}{2}at^2$ ,

$$\text{we get } h = \frac{1}{2}at^2 = \frac{1}{2} \frac{V(\rho_{\text{air}} - \rho_{\text{He}})}{m} gt^2 \quad (3)$$

From Eqs. (3) and (2),

$$\begin{aligned} \frac{1}{2}mv^2 &= [V(\rho_a - \rho_{\text{He}})g] \left[ \frac{1}{2m} V(\rho_a - \rho_{\text{He}}) gt^2 \right] \\ &= V(\rho_a - \rho_{\text{He}})gh \end{aligned}$$

Rearranging the terms,

$$\begin{aligned} \Rightarrow \frac{1}{2}mv^2 + V\rho_{\text{He}}gh &= V\rho_{\text{air}}hg \\ \Rightarrow KE_{\text{balloon}} + PE_{\text{balloon}} &= \text{change in PE of air.} \end{aligned}$$

So, as the balloon goes up, an equal volume of air comes down, increase in PE and KE of the balloon is at the cost of PE of air [which comes down].

## Chapter 7

7.1 (d)

7.2 (c)

7.3 The initial velocity is  $\mathbf{v}_i = v\hat{\mathbf{e}}_y$  and, after reflection from the wall, the final velocity is  $\mathbf{v}_f = -v\hat{\mathbf{e}}_y$ . The trajectory is described as  $\mathbf{r} = y\hat{\mathbf{e}}_y + a\hat{\mathbf{e}}_z$ . Hence the change in angular momentum is  $\mathbf{r} \times m(\mathbf{v}_f - \mathbf{v}_i) = 2mva\hat{\mathbf{e}}_x$ . Hence the answer is (b).

7.4 (d)

7.5 (b)

7.6 (c)

7.7 When  $b \rightarrow 0$ , the density becomes uniform and hence the centre of mass is at  $x = 0.5$ . Only option (a) tends to 0.5 as  $b \rightarrow 0$ .

7.8 (b)  $\omega$

7.9 (a), (c)

7.10 (a), (d)

7.11 All are true.

- 7.12** (a) False, it is along  $\hat{\mathbf{k}}$ .  
 (b) True  
 (c) True  
 (d) False, there is no sense in adding torques about 2 different axes.
- 7.13** (a) False, perpendicular axis theorem is applicable only to a lamina.  
 (b) True  
 (c) False,  $z$  and  $z''$  are not parallel axes.  
 (d) True.
- 7.14** When the vertical height of the object is very small as compared to earth's radius, we call the object small, otherwise it is extended.  
 (a) Building and pond are small objects.  
 (b) A deep lake and a mountain are examples of extended objects.
- 7.15**  $I = \sum m_i r_i^2$ . All the mass in a cylinder lies at distance  $R$  from the axis of symmetry but most of the mass of a solid sphere lies at a smaller distance than  $R$ .
- 7.16** Positive slope indicates anticlockwise rotation which is traditionally taken as positive.
- 7.17** (a) ii, (b) iii, (c) i, (d) iv
- 7.18** (a) iii, (b) iv (c) ii (d) i.
- 7.19** No. Given  $\sum_i \mathbf{F}_i \neq 0$   
 The sum of torques about a certain point 'O'  

$$\sum_i \mathbf{r}_i \times \mathbf{F}_i = 0$$
  
 The sum of torques about any other point O',  

$$\sum_i (\mathbf{r}_i - \mathbf{a}) \times \mathbf{F}_i = \sum_i \mathbf{r}_i \times \mathbf{F}_i - \mathbf{a} \times \sum_i F_i$$
  
 Here, the second term need not vanish.
- 7.20** The centripetal acceleration in a wheel arise due to the internal elastic forces which in pairs cancel each other; being part of a symmetrical system.



In a half wheel the distribution of mass about its centre of mass (axis of rotation) is not symmetrical. Therefore, the direction of angular momentum does not coincide with the direction of angular velocity and hence an external torque is required to maintain rotation.

**7.21** No. A force can produce torque only along a direction normal to itself as  $\boldsymbol{\tau} = \mathbf{r} \times \mathbf{f}$ . So, when the door is in the  $xy$ -plane, the torque produced by gravity can only be along  $\pm z$  direction, never about an axis passing through  $y$  direction.

**7.22** Let the C.M. be 'b'. Then,  $\frac{(n-1)mb + ma}{mn} = 0 \Rightarrow b = -\frac{1}{n-1}a$

**7.23** (a) Surface density  $\sigma = \frac{2M}{\pi a^2}$

$$\begin{aligned} \bar{x} &= \frac{\int x dm}{\int dm} = \frac{\int_{r=0}^a \int_{\theta=0}^{\pi} r \cos \theta \sigma r dr d\theta}{\int_{r=0}^a \int_{\theta=0}^{\pi} \sigma r dr d\theta} \\ &= \frac{\int_0^a r^2 dr \int_0^{\pi} \sin \theta d\theta}{\int_0^a r dr \int_0^{\pi} d\theta} = 0 \end{aligned}$$

$$\begin{aligned} \bar{y} &= \frac{\int y dm}{\int dm} = \frac{\int_{\theta=0}^{\pi} \int_{r=0}^a r \sin \theta \sigma r dr d\theta}{\int_{r=0}^a \int_{\theta=0}^{\pi} \sigma r dr d\theta} \\ &= \frac{\int_0^a r^2 dr \int_0^{\pi} \sin \theta d\theta}{\int_0^a r dr \int_0^{\pi} d\theta} = \frac{a^3 [-\cos \theta]_0^{\pi}}{3 (a^2/2) \pi} = \frac{a \cdot 4}{3 \pi} = \frac{4a}{3\pi} \end{aligned}$$

(b) Same procedure, as in (a) except  $\theta$  goes from 0 to  $\pi/2$  and

$$\sigma = \frac{4M}{\pi a^2} .$$

**7.24** (a) Yes, because there is no net external torque on the system. External forces, gravitation and normal reaction, act through the axis of rotation, hence produce no torque.

(b) By angular momentum conservation

$$I\omega = I_1\omega_1 + I_2\omega_2$$

$$\therefore \omega = \frac{I_1\omega_1 + I_2\omega_2}{I_1 + I_2}$$

$$(c) K_f = \frac{1}{2}(I_1 + I_2) \frac{(I_1\omega_1 + I_2\omega_2)^2}{(I_1 + I_2)^2} = \frac{1}{2} \frac{(I_1\omega_1 + I_2\omega_2)^2}{I_1 + I_2}$$

$$K_i = \frac{1}{2}(I_1\omega_1^2 + I_2\omega_2^2)$$

$$\Delta K = K_f - K_i = -\frac{I_1 I_2}{2(I_1 + I_2)}(\omega_1 - \omega_2)^2$$

(d) The loss in kinetic energy is due to the work against the friction between the two discs.

**7.25** (a) Zero (b) Decreases (c) Increases (d) Friction (e)  $v_{cm} = R\omega$ .

(f) Acceleration produced in centre of mass due to friction:

$$a_{cm} = \frac{F}{m} = \frac{\mu_k mg}{m} = \mu_k g.$$

Angular acceleration produced by the torque due to friction,

$$\alpha = \frac{\tau}{I} = \frac{\mu_k mgR}{I}$$

$$\therefore v_{cm} = u_{cm} + a_{cm}t \Rightarrow v_{cm} = \mu_k gt$$

$$\text{and } \omega = \omega_o + \alpha t \Rightarrow \omega = \omega_o - \frac{\mu_k mgR}{I}t$$

For rolling without slipping,

$$\frac{v_{cm}}{R} = \omega_o - \frac{\mu_k mgR}{I}t$$

$$\frac{\mu_k gt}{R} = \omega_o - \frac{\mu_k mgR}{I}t$$

$$t = \frac{R\omega_o}{\mu_k g \left(1 + \frac{mR^2}{I}\right)}$$

**7.26** (a)

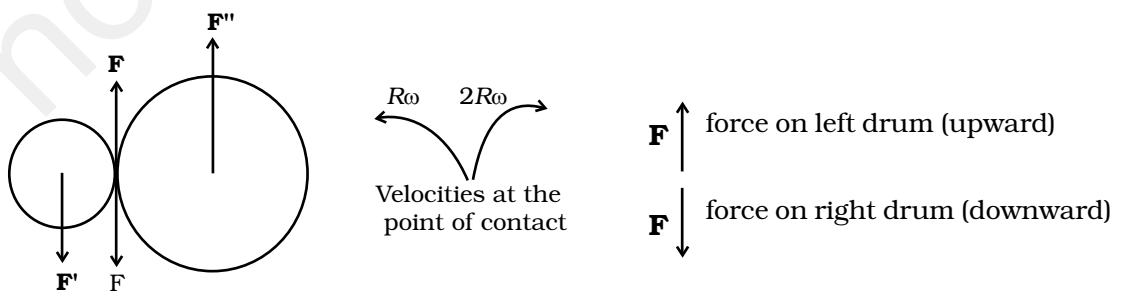

(b)  $F' = F = F''$  where  $F$  and  $F''$  and external forces through support.

$$F_{\text{net}} = 0$$

External torque =  $F \times 3R$ , anticlockwise.

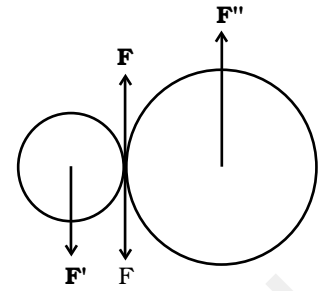

(c) Let  $\omega_1$  and  $\omega_2$  be final angular velocities (anticlockwise and clockwise respectively)

Finally there will be no friction.

$$\text{Hence, } R \omega_1 = 2 R \omega_2 \Rightarrow \frac{\omega_1}{\omega_2} = 2$$

7.27 (i) Area of square = area of rectangle  $\Rightarrow c^2 = ab$

$$\frac{I_{xR}}{I_{xS}} \times \frac{I_{yR}}{I_{yS}} = \frac{b^2}{c^2} \times \frac{a^2}{c^2} = \left(\frac{ab}{c^2}\right)^2 = 1$$

(i) and (ii)  $\frac{I_{yR}}{I_{yS}} > \frac{I_{xR}}{I_{xS}} \Rightarrow \frac{I_{yR}}{I_{yS}} > 1$

$$\text{and } \frac{I_{xR}}{I_{xS}} < 1.$$

$$\begin{aligned} \text{(iii) } I_{zR} - I_{zS} &\propto (a^2 + b^2 - 2c^2) \\ &= a^2 + b^2 - 2ab > 0 \end{aligned}$$

$$\therefore (I_{zR} - I_{zS}) > 0$$

$$\therefore \frac{I_{zR}}{I_{zS}} > 1.$$

7.28 Let the acceleration of the centre of mass of disc be 'a', then

$$Ma = F - f \tag{1}$$

The angular acceleration of the disc is  $\alpha = a/R$ . (if there is no sliding).

Then

$$\left(\frac{1}{2}MR^2\right)\alpha = Rf \tag{2}$$

$$\Rightarrow Ma = 2f$$

Thus,  $f = F/3$ . Since there is no sliding,

$$\Rightarrow f \leq \mu mg$$

$$\Rightarrow F \leq 3\mu Mg.$$

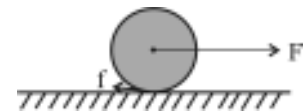

Chapter 8

- 8.1 (d)
- 8.2 (c)
- 8.3 (a)
- 8.4 (c)
- 8.5 (b)
- 8.6 (d)
- 8.7 (d)
- 8.8 (c)
- 8.9 (a), (c)
- 8.10 (a), (c)
- 8.11 (a), (c), (d)
- 8.12 (c), (d)
- 8.13 (c), (d)
- 8.14 (a), (c), (d)
- 8.15 (a), (c)
- 8.16 (d)

8.17 Molecules experience the vertically downward force due to gravity just like an apple falling from a tree. Due to thermal motion, which is random, their velocity is not in the vertical direction. The downward force of gravity causes the density of air in the atmosphere close to earth higher than the density as we go up.

8.18 Central force; gravitational force of a point mass, electrostatic force due to a point charge.

Non-central force: spin-dependent nuclear forces, magnetic force between two current carrying loops.

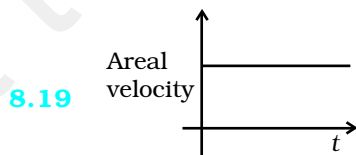

8.20 It is normal to the plane containing the earth and the sun as areal velocity

$$\frac{\Delta \mathbf{A}}{\Delta t} = \frac{1}{2} \mathbf{r} \times \mathbf{v} \Delta t.$$

- 8.21** It remains same as the gravitational force is independent of the medium separating the masses.
- 8.22** Yes, a body will always have mass but the gravitational force on it can be zero; for example, when it is kept at the centre of the earth.
- 8.23** No.
- 8.24** Yes, if the size of the spaceship is large enough for him to detect the variation in  $g$ .

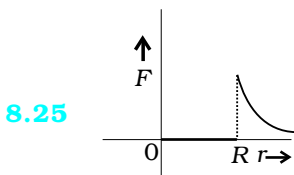

- 8.26** At perihelion because the earth has to cover greater linear distance to keep the areal velocity constant.
- 8.27** (a)  $90^\circ$  (b)  $0^\circ$
- 8.28** Every day the earth advances in the orbit by approximately  $1^\circ$ . Then, it will have to rotate by  $361^\circ$  (which we define as 1 day) to have sun at zenith point again. Since  $361^\circ$  corresponds to 24 hours; extra  $1^\circ$  corresponds to approximately 4 minute [3 min 59 seconds].

- 8.29** Consider moving the mass at the middle by a small amount  $h$  to the right. Then the forces on it are:  $\frac{GMm}{(R-h)^2}$  to the

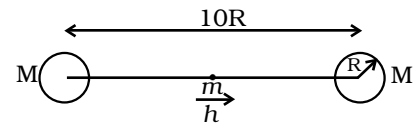

right and  $\frac{GMm}{(R+h)^2}$  to the left. The first is larger than the second. Hence the net force will also be towards the right. Hence the equilibrium is unstable.

**8.30**

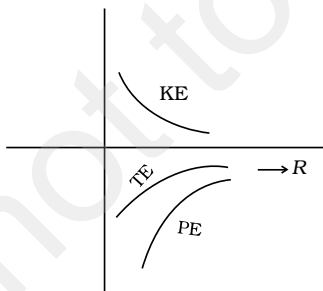

- 8.31** The trajectory of a particle under gravitational force of the earth will be a conic section (for motion outside the earth) with the centre of the earth as a focus. Only (c) meets this requirement.

8.32  $mgR/2$ .

8.33 Only the horizontal component (i.e. along the line joining  $m$  and O) will survive. The horizontal component of the force on any point on the ring changes by a factor:

$$\left[ \frac{2r}{(4r^2 + r^2)^{3/2}} \right] \left[ \frac{\mu}{(r^2 + r^2)^{3/2}} \right]$$

$$= \frac{4\sqrt{2}}{5\sqrt{5}}.$$

8.34 As  $r$  increases:

$$U \left( = -\frac{GMm}{r} \right) \text{ increases.}$$

$$v_c \left( = \sqrt{\frac{GM}{r}} \right) \text{ decreases.}$$

$$\omega \left( = \frac{v_c}{r} \times \frac{1}{r^{3/2}} \right) \text{ decreases.}$$

$K$  decreases because  $v$  increases.

$E$  increases because  $|U| = 2K$  and  $U < 0$

$l$  increases because  $mvr \propto \sqrt{r}$ .

8.35  $AB = C$

$$(AC) = 2 AG = 2.l \cdot \frac{\sqrt{3}}{2} = \sqrt{3}l$$

$$AD = AH + HJ + JD$$

$$= \frac{l}{2} + l + \frac{l}{2}$$

$$= 2l.$$

$$AE = AC = \sqrt{3}l, \quad AF = l$$

Force along AD due to  $m$  at F and B

$$= Gm^2 \left[ \frac{1}{l^2} \right] \frac{1}{2} + Gm^2 \left[ \frac{1}{l^2} \right] \frac{1}{2} = \frac{Gm^2}{l^2}$$

Force along AD due to masses at E and C

$$= Gm^2 \frac{1}{3l^2} \cos(30^\circ) + \frac{Gm^2}{3l^2} \cos(30^\circ)$$

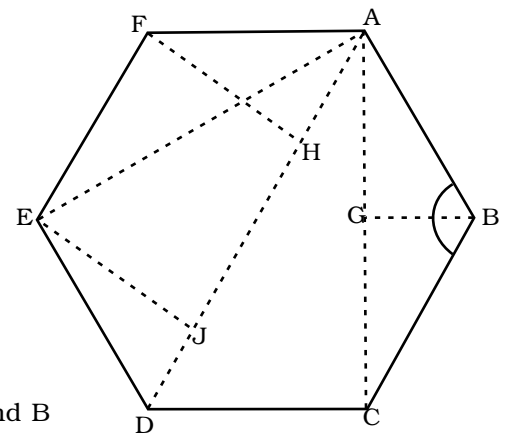

$$= \frac{Gm^2}{3l^2} \sqrt{3} = \frac{Gm^2}{\sqrt{3}l^2}.$$

Force due to mass  $M$  at D

$$= \frac{Gm^2}{4l^2}.$$

$$\therefore \text{Total Force} = \frac{Gm^2}{l^2} \left[ 1 + \frac{1}{\sqrt{3}} + \frac{1}{4} \right].$$

**8.36** (a)  $r = \left( \frac{GMT^2}{4\pi^2} \right)^{1/3}$

$$\begin{aligned} \therefore h &= \left( \frac{GMT^2}{4\pi^2} \right)^{1/3} - R \\ &= 4.23 \times 10^7 - 6.4 \times 10^6 \\ &= 3.59 \times 10^7 \text{ m.} \end{aligned}$$

(b)  $\theta = \cos^{-1} \left( \frac{R}{R+h} \right)$

$$= \cos^{-1} \left( \frac{1}{1+h/r} \right)$$

$$= \cos^{-1} \left( \frac{1}{1+5.61} \right)$$

$$= 81^\circ 18'$$

$$\therefore 2\theta = 162^\circ 36'$$

$$\frac{360^\circ}{2\theta} \approx 2.21; \text{ Hence minimum number} = 3.$$

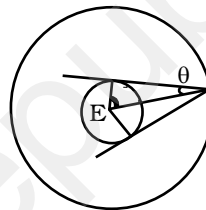

**8.37** Angular momentum and areal velocity are constant as earth orbits the sun.

At perigee  $r_p^2 \omega_p = r_a^2 \omega_a$  at apogee.

If ' $a$ ' is the semi-major axis of earth's orbit, then  $r_p = a(1 - e)$  and

$$r_a = a(1 + e).$$

$$\therefore \frac{\omega_p}{\omega_a} = \left( \frac{1+e}{1-e} \right)^2, \quad e = 0.0167$$

$$\therefore \frac{\omega_p}{\omega_a} = 1.0691$$

Let  $\omega$  be angular speed which is geometric mean of  $\omega_p$  and  $\omega_a$  and corresponds to mean solar day,

$$\therefore \left(\frac{\omega_p}{\omega}\right)\left(\frac{\omega}{\omega_a}\right) = 1.0691$$

$$\therefore \frac{\omega_p}{\omega} = \frac{\omega}{\omega_a} = 1.034.$$

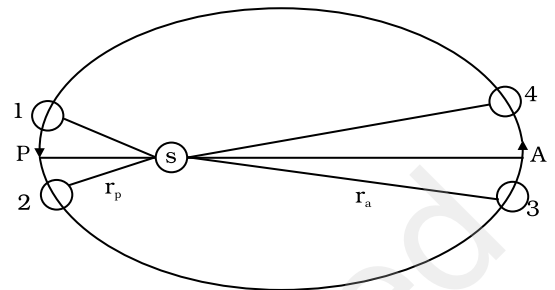

If  $\omega$  corresponds to  $1^\circ$  per day (mean angular speed), then

$\omega_p = 1.034^\circ$  per day and  $\omega_a = 0.967^\circ$  per day. Since  $361^\circ = 14$  hrs: mean solar day, we get  $361.034^\circ$  which corresponds to 24 hrs 8.14" (8.1" longer) and  $360.967^\circ$  corresponds to 23 hrs 59 min 52" (7.9" smaller).

This does not explain the actual variation of the length of the day during the year.

**8.38**  $r_a = a(1 + e) = 6R$   
 $r_p = a(1 - e) = 2R \Rightarrow e = \frac{1}{2}$

Conservation of angular momentum:

angular momentum at perigee = angular momentum at apogee

$$\therefore m v_p r_p = m v_a r_a$$

$$\therefore \frac{v_a}{v_p} = \frac{1}{3}.$$

Conservation of Energy:

Energy at perigee = Energy at apogee

$$\frac{1}{2} m v_p^2 - \frac{GMm}{r_p} = \frac{1}{2} m v_a^2 - \frac{GMm}{r_a}$$

$$\therefore v_p^2 \left(1 - \frac{1}{9}\right) = -2GM \left[\frac{1}{r_a} - \frac{1}{r_p}\right] = 2GM \left[\frac{1}{r_a} - \frac{1}{r_p}\right]$$

$$v_p = \frac{2GM \left[\frac{1}{r_p} - \frac{1}{r_a}\right]^{1/2}}{\left[1 - \left(\frac{v_a}{v_p}\right)\right]^2} = \left[\frac{2GM \left[\frac{1}{2} - \frac{1}{6}\right]}{\left(1 - \frac{1}{9}\right)}\right]^{1/2}$$



$$= \left( \frac{2/3 GM}{8/9 R} \right)^{1/2} = \sqrt{\frac{3 GM}{4 R}} = 6.85 \text{ km/s}$$

$$v_p = 6.85 \text{ km/s}, \quad v_a = 2.28 \text{ km/s}.$$

$$\text{For } r = 6R, \quad v_c = \sqrt{\frac{GM}{6R}} = 3.23 \text{ km/s}.$$

Hence to transfer to a circular orbit at apogee, we have to boost the velocity by  $\Delta = (3.23 - 2.28) = 0.95 \text{ km/s}$ . This can be done by suitably firing rockets from the satellite.

## Chapter 9

- 9.1 (b)  
 9.2 (d)  
 9.3 (d)  
 9.4 (c)  
 9.5 (b)  
 9.6 (a)  
 9.7 (c)  
 9.8 (d)  
 9.9 (c), (d)  
 9.10 (a), (d)  
 9.11 (b), (d)  
 9.12 (a), (d)  
 9.13 (a), (d)  
 9.14 Steel  
 9.15 No  
 9.16 Copper  
 9.17 Infinite  
 9.18 Infinite

**9.19** Let  $Y$  be the Young's modulus of the material. Then

$$Y = \frac{f / \pi r^2}{l / L}$$

Let the increase in length of the second wire be  $l'$ . Then

$$\frac{2f}{\frac{4\pi r^2}{l' / 2L}} = Y$$

$$\text{Or, } l' = \frac{1}{Y} \frac{2f}{4\pi r^2} 2L = \frac{l}{L} \frac{\pi r^2}{f} \times \frac{2f}{4\pi r^2} 2L = l$$

**9.20** Because of the increase in temperature the increase in length per unit length of the rod is

$$\frac{\Delta l}{l_0} = \alpha \Delta T = 10^{-5} \times 2 \times 10^{-2} = 2 \times 10^{-3}$$

Let the compressive tension on the rod be  $T$  and the cross sectional area be  $a$ , then

$$\frac{T/a}{\Delta l / l_0} = Y$$

$$\begin{aligned} \therefore T &= Y \frac{\Delta l}{l_0} \times a = 2 \times 10^{11} \times 2 \times 10^{-3} \times 10^{-4} \\ &= 4 \times 10^4 \text{ N} \end{aligned}$$

**9.21** Let the depth be  $h$ , then the pressure is

$$P = \rho gh = 10^3 \times 9.8 \times h$$

$$\text{Now } \left| \frac{P}{\Delta V / V} \right| = B$$

$$\therefore P = B \frac{\Delta V}{V} = 9.8 \times 10^8 \times 0.1 \times 10^{-2}$$

$$\therefore h = \frac{9.8 \times 10^8 \times 0.1 \times 10^{-2}}{9.8 \times 10^3} = 10^2 \text{ m}$$

**9.22** Let the increase in length be  $\Delta l$ , then

$$\frac{800}{(\pi \times 25 \times 10^{-6}) / (\Delta l / 9.1)} = 2 \times 10^{11}$$

$$\therefore \Delta l = \frac{9.1 \times 800}{\pi \times 25 \times 10^{-6} \times 2 \times 10^{11}} \text{ m}$$

$$\approx 0.5 \times 10^{-3} \text{ m}$$

**9.23** As the ivory ball is more elastic than the wet-clay ball, it will tend to retain its shape instantaneously after the collision. Hence, there will be a large energy and momentum transfer compared to the wet clay ball. Thus, the ivory ball will rise higher after the collision.

**9.24** Let the cross sectional area of the bar be  $A$ . Consider the equilibrium of the plane  $aa'$ . A force  $\mathbf{F}$  must be acting on this plane making an angle  $\frac{\pi}{2} - \theta$  with the normal  $ON$ . Resolving  $\mathbf{F}$  into components, along the plane and normal to the plane

$$F_p = F \cos \theta$$

$$F_N = F \sin \theta$$

Let the area of the face  $aa'$  be  $A'$ , then

$$\frac{A}{A'} = \sin \theta$$

$$\therefore A' = \frac{A}{\sin \theta}$$

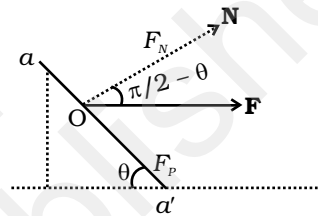

The tensile stress  $T = \frac{F \sin \theta}{A'} = \frac{F}{A} \sin^2 \theta$  and the shearing stress  $Z = \frac{F \cos \theta}{A'} = \frac{F}{A} \cos \theta \sin \theta = \frac{F \sin 2\theta}{2A}$ . Maximum tensile stress is when  $\theta = \pi/2$  and maximum shearing stress when  $2\theta = \pi/2$  or  $\theta = \pi/4$ .

**9.25** (a) Consider an element  $dx$  at a distance  $x$  from the load ( $x = 0$ ). If  $T(x)$  and  $T(x + dx)$  are tensions on the two cross sections a distance  $dx$  apart, then

$$T(x + dx) - T(x) = \mu g dx \text{ (where } \mu \text{ is the mass/length)}$$

$$\frac{dT}{dx} dx = \mu g dx$$

$$\Rightarrow T(x) = \mu g x + C$$

$$\text{At } x = 0, T(0) = Mg \Rightarrow C = Mg$$

$$\therefore T(x) = \mu g x + Mg$$

Let the length  $dx$  at  $x$  increase by  $dr$ , then

$$\frac{T(x)/A}{dr/dx} = Y$$

$$\text{or, } \frac{dr}{dx} = \frac{1}{YA} T(x)$$

$$\Rightarrow r = \frac{1}{YA} \int_0^L (\mu gx + Mg) dx$$

$$= \frac{1}{YA} \left[ \frac{\mu gx^2}{2} + Mgx \right]_0^L$$

$$= \frac{1}{YA} \left[ \frac{mgl}{2} + MgL \right]$$

( $m$  is the mass of the wire)

$$A = \pi \times (10^{-3})^2 \text{ m}^2, Y = 200 \times 10^9 \text{ Nm}^{-2}$$

$$m = \pi \times (10^{-3})^2 \times 10 \times 7860 \text{ kg}$$

$$\therefore r = \frac{1}{2 \times 10^{11} \times \pi \times 10^{-6}} \left[ \frac{\pi \times 786 \times 10^{-7} \times 10 \times 10}{2} + 25 \times 10 \times 10 \right]$$

$$= [196.5 \times 10^{-6} + 3.98 \times 10^{-3}] \sim 4 \times 10^{-3} \text{ m}$$

(b) The maximum tension would be at  $x = L$ .

$$T = \mu gL + Mg = (m + M)g$$

The yield force

$$= 250 \times 10^6 \times \pi \times (10^{-3})^2 = 250 \times \pi \text{ N}$$

At yield

$$(m + M)g = 250 \times \pi$$

$$m = \pi \times (10^{-3})^2 \times 10 \times 7860 \ll M \therefore Mg \sim 250 \times \pi$$

$$\text{Hence, } M = \frac{250 \times \pi}{10} = 25 \times \pi \sim 75 \text{ kg.}$$

**9.26** Consider an element at  $r$  of width  $dr$ . Let  $T(r)$  and  $T(r+dr)$  be the tensions at the two edges.

$$-T(r+dr) + T(r) = \mu \omega^2 r dr \text{ where } \mu \text{ is the mass/length}$$

$$-\frac{dT}{dr} dr = \mu \omega^2 r dr$$

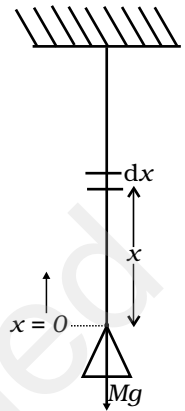

At  $r = l$   $T = 0$

$$\Rightarrow C = \frac{\mu\omega^2 l^2}{2}$$

$$\therefore T(r) = \frac{\mu\omega^2}{2} (l^2 - r^2)$$

Let the increase in length of the element  $dr$  be  $d(\delta)$

$$Y = \frac{(\mu\omega^2/2)(l^2 - r^2)/A}{\frac{d(\delta)}{dr}}$$

$$\therefore \frac{d(\delta)}{dr} = \frac{1}{YA} \frac{\mu\omega^2}{2} (l^2 - r^2)$$

$$\therefore d(\delta) = \frac{1}{YA} \frac{\mu\omega^2}{2} (l^2 - r^2) dr$$

$$\therefore \delta = \frac{1}{YA} \frac{\mu\omega^2}{2} \int_0^l (l^2 - r^2) dr$$

$$= \frac{1}{YA} \frac{\mu\omega^2}{2} \left[ l^3 - \frac{l^3}{3} \right] = \frac{1}{3YA} \mu\omega^2 l^3 = \frac{1}{3YA} \mu\omega^2 l^2$$

The total change in length is  $2\delta = \frac{2}{3YA} \mu\omega^2 l^2$

9.27 Let  $l_1 = AB$ ,  $l_2 = AC$ ,  $l_3 = BC$

$$\cos \theta = \frac{l_3^2 + l_1^2 - l_2^2}{2l_3 l_1}$$

$$\text{Or, } 2l_3 l_1 \cos \theta = l_3^2 + l_1^2 - l_2^2$$

Differentiating

$$2(l_3 dl_1 + l_1 dl_3) \cos \theta - 2l_1 l_3 \sin \theta d\theta$$

$$= 2l_3 dl_3 + 2l_1 dl_3 + 2l_1 \alpha_1 - 2l_2 \alpha_2$$

$$\text{Now, } dl_1 = l_1 \alpha_1 \Delta t$$

$$dl_2 = l_2 \alpha_2 \Delta t$$

$$dl_3 = l_3 \alpha_3 \Delta t$$

$$\text{and } l_1 = l_2 = l_3 = l$$

$$(l^2 \alpha_1 \Delta t + l^2 \alpha_1 \Delta t) \cos \theta + l^2 \sin \theta d\theta = l^2 \alpha_1 \Delta t + l^2 \alpha_1 \Delta t - l^2 \alpha_2 \Delta t$$

$$\sin \theta d\theta = 2\alpha_1 \Delta t (1 - \cos \theta) - \alpha_2 \Delta t$$

Putting  $\theta = 60^\circ$

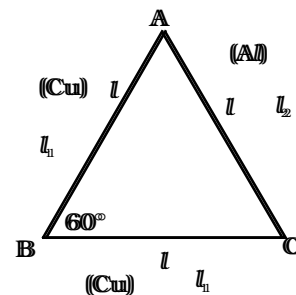
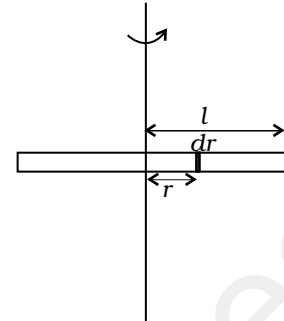

$$d\theta \frac{\sqrt{3}}{2} = 2\alpha_1 \Delta t \times (1/2) - \alpha_2 \Delta t$$

$$= (\alpha_1 - \alpha_2) \Delta t$$

$$\text{Or, } d\theta = \frac{2(\alpha_1 - \alpha_2) \Delta t}{\sqrt{3}}$$

**9.28** When the tree is about to buckle

$$Wd = \frac{Y\pi r^4}{4R}$$

If  $R \gg h$ , then the centre of gravity is at a height  $l = \frac{1}{2}h$  from the ground.

From  $\triangle ABC$

$$R^2 = (R-d)^2 + \left(\frac{1}{2}h\right)^2$$

If  $d \ll R$

$$R^2 \approx R^2 - 2Rd + \frac{1}{4}h^2$$

$$\therefore d = \frac{h^2}{8R}$$

If  $w_0$  is the weight/volume

$$\frac{Y\pi r^4}{4R} = w_0(\pi r^2 h) \frac{h^2}{8R}$$

$$\Rightarrow h = \left(\frac{2Y}{w_0}\right)^{1/3} r^{2/3}$$

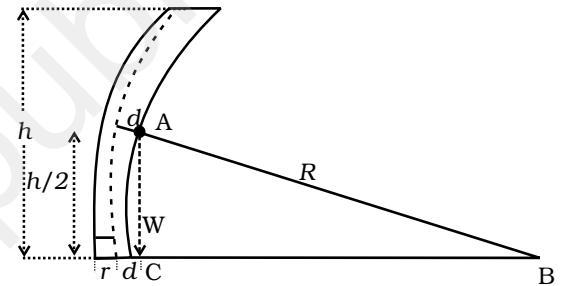

**9.29** (a) Till the stone drops through a length  $L$  it will be in free fall. After that the elasticity of the string will force it to a SHM. Let the stone come to rest instantaneously at  $y$ .

The loss in P.E. of the stone is the P.E. stored in the stretched string.

$$mgy = \frac{1}{2}k(y-L)^2$$

$$\text{Or, } mgy = \frac{1}{2}ky^2 - kyL + \frac{1}{2}kL^2$$

$$\text{Or, } \frac{1}{2}ky^2 - (kL + mg)y + \frac{1}{2}kL^2 = 0$$

$$y = \frac{(kL + mg) \pm \sqrt{(kL + mg)^2 - k^2L^2}}{k}$$

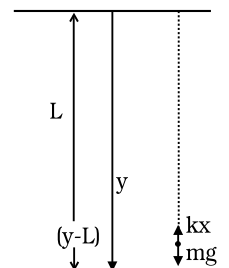

$$= \frac{(kL + mg) \pm \sqrt{2mgkL + m^2g^2}}{k}$$

Retain the positive sign.

$$\therefore y = \frac{(kL + mg) + \sqrt{2mgkL + m^2g^2}}{k}$$

- (b) The maximum velocity is attained when the body passes, through the “equilibrium, position” i.e. when the instantaneous acceleration is zero. That is  $mg - kx = 0$  where  $x$  is the extension from  $L$ :

$$\Rightarrow mg = kx$$

Let the velocity be  $v$ . Then

$$\frac{1}{2}mv^2 + \frac{1}{2}kx^2 = mg(L + x)$$

$$\frac{1}{2}mv^2 = mg(L + x) - \frac{1}{2}kx^2$$

Now  $mg = kx$

$$x = \frac{mg}{k}$$

$$\begin{aligned} \therefore \frac{1}{2}mv^2 &= mg\left(L + \frac{mg}{k}\right) - \frac{1}{2}k\frac{m^2g^2}{k^2} \\ &= mgL + \frac{m^2g^2}{k} - \frac{1}{2}\frac{m^2g^2}{k} \end{aligned}$$

$$\frac{1}{2}mv^2 = mgL + \frac{1}{2}\frac{m^2g^2}{k}$$

$$\therefore v^2 = 2gL + mg^2/k$$

$$v = (2gL + mg^2/k)^{1/2}$$

- (c) Consider the particle at an instantaneous position  $y$ . Then

$$\frac{md^2y}{dt^2} = mg - k(y - L)$$

$$\Rightarrow \frac{d^2y}{dt^2} + \frac{k}{m}(y - L) - g = 0$$

Make a transformation of variables:  $z = \frac{k}{m}(y - L) - g$

Then  $\frac{d^2z}{dt^2} + \frac{k}{m}z = 0$

$\therefore z = A \cos(\omega t + \phi)$  where  $\omega = \sqrt{\frac{k}{m}}$

$\Rightarrow y = \left(L + \frac{m}{k}g\right) + A' \cos(\omega t + \phi)$

Thus the stone performs SHM with angular frequency  $\omega$  about the point

$y_0 = L + \frac{m}{k}g$

## Chapter 10

10.1 (c)

10.2 (d)

10.3 (b)

10.4 (a)

10.5 (c)

10.6 (a), (d)

10.7 (c), (d)

10.8 (a), (b)

10.9 (c), (d)

10.10 (b), (c)

10.11 No.

10.12 No.

10.13 Let the volume of the iceberg be  $V$ . The weight of the iceberg is  $\rho_i Vg$ . If  $x$  is the fraction submerged, then the volume of water displaced is  $xV$ . The buoyant force is  $\rho_w xVg$  where  $\rho_w$  is the density of water.

$\rho_i Vg = \rho_w xVg$

$\therefore x = \frac{\rho_i}{\rho_w} = 0.917$

10.14 Let  $x$  be the compression on the spring. As the block is in equilibrium

$Mg - (kx + \rho_w Vg) = 0$



where  $\rho_w$  is the density of water and  $V$  is the volume of the block. The reading in the pan is the force applied by the water on the pan i.e.,

$$m_{\text{vessel}} + m_{\text{water}} + \rho_w Vg.$$

Since the scale has been adjusted to zero without the block, the new reading is  $\rho_w Vg$ .

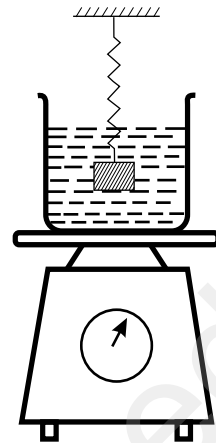

**10.15** Let the density of water be  $\rho_w$ .

$$\text{Then } \rho aL^3 + \rho L^3g = \rho_w xL^3 (g + a)$$

$$\therefore x = \frac{\rho}{\rho_w}$$

Thus, the fraction of the block submerged is independent of any acceleration, whether gravity or elevator.

**10.16** The height to which the sap will rise is

$$h = \frac{2T \cos 0^\circ}{\rho gr} = \frac{2(7.2 \times 10^{-2})}{10^3 \times 9.8 \times 2.5 \times 10^{-5}} \approx 0.6\text{m}$$

This is the maximum height to which the sap can rise due to surface tension. Since many trees have heights much more than this, capillary action alone cannot account for the rise of water in all trees.

**10.17** If the tanker accelerates in the positive  $x$  direction, then the water will bulge at the back of the tanker. The free surface will be such that the tangential force on any fluid parcel is zero.

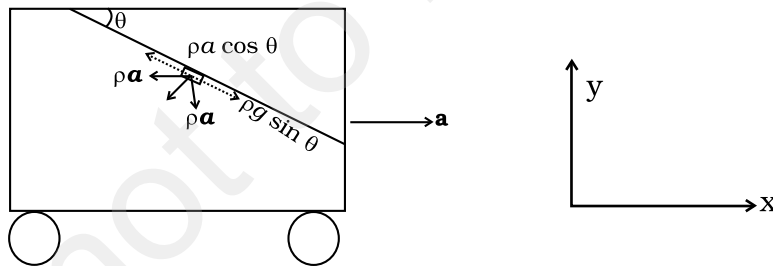

Consider a parcel at the surface, of unit volume. The forces on the fluid are

$$-\rho g \hat{\mathbf{y}} \quad \text{and} \quad -\rho a \hat{\mathbf{x}}$$

The component of the weight along the surface is  $\rho g \sin \theta$

The component of the acceleration force along the surface is

$$\rho a \cos \theta$$

$$\therefore \rho g \sin \theta = \rho a \cos \theta$$

Hence,  $\tan \theta = a/g$

**10.18** Let  $v_1$  and  $v_2$  be the volume of the droplets and  $v$  of the resulting drop.

Then  $v = v_1 + v_2$

$$\Rightarrow r^3 = r_1^3 + r_2^3 = (0.001 + 0.008) \text{ cm}^3 = 0.009 \text{ cm}^3$$

$$\therefore r = 0.21 \text{ cm}$$

$$\begin{aligned} \therefore \Delta U &= 4\pi T (r^2 - (r_1^2 + r_2^2)) \\ &= 4\pi \times 435.5 \times 10^{-3} (0.21^2 - 0.05) \times 10^{-4} \text{ J} \\ &\approx -32 \times 10^{-7} \text{ J} \end{aligned}$$

**10.19**  $R^3 = Nr^3$

$$\Rightarrow r = \frac{R}{N^{1/3}}$$

$$\Delta U = 4\pi T (R^2 - Nr^2)$$

Suppose all this energy is released at the cost of lowering the temperature. If  $s$  is the specific heat then the change in temperature would be,

$$\Delta \theta = \frac{\Delta U}{ms} = \frac{4\pi T (R^2 - Nr^2)}{\frac{4}{3} \pi R^3 \rho s}, \text{ where } \rho \text{ is the density.}$$

$$\begin{aligned} \therefore \Delta \theta &= \frac{3T}{\rho s} \left( \frac{1}{R} - \frac{r^2}{R^3} N \right) \\ &= \frac{3T}{\rho s} \left( \frac{1}{R} - \frac{r^2 R^3}{R^3 r^3} \right) = \frac{3T}{\rho s} \left( \frac{1}{R} - \frac{1}{r} \right) \end{aligned}$$

**10.20** The drop will evaporate if the water pressure is more than the vapour pressure. The membrane pressure (water)

$$p = \frac{2T}{r} = 2.33 \times 10^3 \text{ Pa}$$

$$\therefore r = \frac{2T}{p} = \frac{2(7.28 \times 10^{-2})}{2.33 \times 10^3} = 6.25 \times 10^{-5} \text{ m}$$

- 10.21 (a) Consider a horizontal parcel of air with cross section  $A$  and height  $dh$ . Let the pressure on the top surface and bottom surface be  $p$  and  $p+dp$ . If the parcel is in equilibrium, then the net upward force must be balanced by the weight.

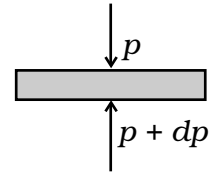

$$\text{i.e. } (p+dp)A - pA = -PgAdh$$

$$\Rightarrow dp = -\rho gdh.$$

- (b) Let the density of air on the earth's surface be  $\rho_o$ , then

$$\frac{p}{p_o} = \frac{\rho}{\rho_o}$$

$$\Rightarrow \rho = \frac{\rho_o}{p_o} p$$

$$\therefore dp = -\frac{\rho_o g}{p_o} p dh$$

$$\Rightarrow \frac{dp}{p} = -\frac{\rho_o g}{p_o} dh$$

$$\Rightarrow \int_{p_o}^p \frac{dp}{p} = -\frac{\rho_o g}{p_o} \int_0^h dh$$

$$\Rightarrow \ln \frac{p}{p_o} = -\frac{\rho_o g}{p_o} h$$

$$\Rightarrow p = p_o \exp\left(-\frac{\rho_o g}{p_o} h\right)$$

- (c)  $\ln \frac{1}{10} = -\frac{\rho_o g}{p_o} h_o$

$$\therefore h_o = -\frac{p_o}{\rho_o g} \ln \frac{1}{10}$$

$$= \frac{p_o}{\rho_o g} \times 2.303$$

$$= \frac{1.013 \times 10^5}{1.29 \times 9.8} \times 2.303 = 0.16 \times 10^5 \text{ m} = 16 \times 10^3 \text{ m}$$

- (d) The assumption  $p \propto \rho$  is valid only for the isothermal case which is only valid for small distances.

10.22 (a) 1 kg of water requires  $L_v$  k cal

$\therefore M_A$  kg of water requires  $M_A L_v$  k cal

Since there are  $N_A$  molecules in  $M_A$  kg of water the energy required for 1 molecule to evaporate is

$$\begin{aligned} u &= \frac{M_A L_v}{N_A} \text{ J} \\ &= \frac{18 \times 540 \times 4.2 \times 10^3}{6 \times 10^{26}} \text{ J} \\ &= 90 \times 18 \times 4.2 \times 10^{-23} \text{ J} \\ &\approx 6.8 \times 10^{-20} \text{ J} \end{aligned}$$

(b) Consider the water molecules to be points at a distance  $d$  from each other.

$N_A$  molecules occupy  $\frac{M_A l}{\rho_w}$

Thus, the volume around one molecule is  $\frac{M_A}{N_A \rho_w} l$

The volume around one molecule is  $d^3 = (M_A/N_A \rho_w)$

$$\begin{aligned} \therefore d &= \left( \frac{M_A}{N_A \rho_w} \right)^{1/3} = \left( \frac{18}{6 \times 10^{26} \times 10^3} \right)^{1/3} \\ &= (30 \times 10^{-30})^{1/3} \text{ m} \approx 3.1 \times 10^{-10} \text{ m} \end{aligned}$$

(c) 1 kg of vapour occupies  $1601 \times 10^{-3} \text{ m}^3$ .

$\therefore$  18 kg of vapour occupies  $18 \times 1601 \times 10^{-3} \text{ m}^3$

$\Rightarrow 6 \times 10^{26}$  molecules occupies  $18 \times 1601 \times 10^{-3} \text{ m}^3$

$\therefore$  1 molecule occupies  $\frac{18 \times 1601 \times 10^{-3}}{6 \times 10^{26}} \text{ m}^3$

If  $d'$  is the inter molecular distance, then

$$d'^3 = (3 \times 1601 \times 10^{-29}) \text{ m}^3$$

$\therefore d' = (30 \times 1601)^{1/3} \times 10^{-10} \text{ m}$

$$= 36.3 \times 10^{-10} \text{ m}$$

$$(d) F(d' - d) = u \Rightarrow F = \frac{u}{d' - d} = \frac{6.8 \times 10^{-20}}{(36.3 - 3.1) \times 10^{-10}} = 0.2048 \times 10^{-10} \text{ N}$$

$$(e) F/d = \frac{0.2048 \times 10^{-10}}{3.1 \times 10^{-10}} = 0.066 \text{ N m}^{-1} = 6.6 \times 10^{-2} \text{ N m}^{-1}$$

**10.23** Let the pressure inside the balloon be  $P_i$  and the outside pressure be  $P_o$ .

$$P_i - P_o = \frac{2\gamma}{r}$$

Considering the air to be an ideal gas

$P_i V = n_i R T_i$  where  $V$  is the volume of the air inside the balloon,  $n_i$  is the number of moles inside and  $T_i$  is the temperature inside, and  $P_o V = n_o R T_o$  where  $V$  is the volume of the air displaced and  $n_o$  is the number of moles displaced and  $T_o$  is the temperature outside.

$$n_i = \frac{P_i V}{R T_i} = \frac{M_i}{M_A} \text{ where } M_i \text{ is the mass of air inside and } M_A \text{ is the molar mass of air and } n_o = \frac{P_o V}{R T_o} = \frac{M_o}{M_A} \text{ where } M_o \text{ is the mass of air outside}$$

that has been displaced. If  $W$  is the load it can raise, then

$$W + M_i g = M_o g$$

$$\Rightarrow W = M_o g - M_i g$$

Air is 21%  $O_2$  and 79%  $N_2$

$$\therefore \text{Molar mass of air } M_A = 0.21 \times 32 + 0.79 \times 28 = 28.84 \text{ g.}$$

$$\begin{aligned} \Rightarrow W &= \frac{M_A V}{R} \left( \frac{P_o}{T_o} - \frac{P_i}{T_i} \right) g \\ &= \frac{0.02884 \times \frac{4}{3} \pi \times 8^3 \times 9.8}{8.314} \left( \frac{1.013 \times 10^5}{293} - \frac{1.013 \times 10^5}{333} - \frac{2 \times 5}{8 \times 313} \right) \text{ N} \\ &\approx \frac{0.02884 \times \frac{4}{3} \pi \times 8^3}{8.314} \times 1.013 \times 10^5 \left( \frac{1}{293} - \frac{1}{333} \right) \times 9.8 \text{ N} \\ &= 3044.2 \text{ N.} \end{aligned}$$

## Chapter 11

11.1 (d)

11.2 (b)

11.3 (b)

11.4 (a)

11.5 (a)

11.6 (a)

11.7 (d)

$$\text{Original volume } V_0 = \frac{4}{3}\pi R^3$$

Coeff of linear expansion =  $\alpha$

$\therefore$  Coeff of volume expansion  $\approx 3\alpha$

$$\therefore \frac{1}{V} \frac{dV}{dT} = 3\alpha$$

$$\Rightarrow dV = 3V\alpha dT \approx 4\pi R^3 \alpha \Delta T$$

11.8 (c)

11.9 (b), (d)

11.10 (b)

11.11 (a), (d)

11.12 (b), (c), (d)

11.13 Diathermic

11.14 2 and 3 are wrong, 4<sup>th</sup> is correct.

11.15 Due to difference in conductivity, metals having high conductivity compared to wood. On touch with a finger, heat from the surrounding flows faster to the finger from metals and so one feels the heat. Similarly, when one touches a cold metal the heat from the finger flows away to the surroundings faster.

11.16  $-40^\circ\text{C} = -40^\circ\text{F}$

11.17 Since Cu has a high conductivity compared to steel, the junction of Cu and steel gets heated quickly but steel does not conduct as quickly, thereby allowing food inside to get heated uniformly.

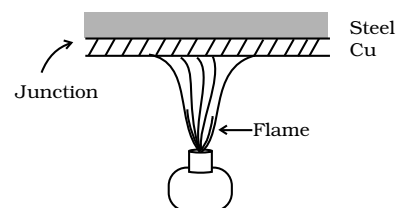

**11.18**  $I = \frac{1}{12} Ml^2$   
 $I' = \frac{1}{12} M(l + \Delta l)^2 = \frac{1}{12} Ml^2 + \frac{1}{12} 2Ml\Delta l + \frac{1}{12} M(\Delta l)^2 \alpha$   
 $\approx I + \frac{1}{12} Ml^2 2\alpha\Delta T$   
 $= I + 2I\alpha\Delta T$   
 $\therefore \Delta I = 2\alpha I\Delta T$

**11.19** Refer to the P.T diagram of water and double headed arrow. Increasing pressure at 0°C and 1 atm takes ice into liquid state and decreasing pressure in liquid state at 0°C and 1 atm takes water to ice state.

When crushed ice is squeezed, some of it melts, filling up gap between ice flakes. Upon releasing pressure, this water freezes binding all ice flakes making the ball more stable.

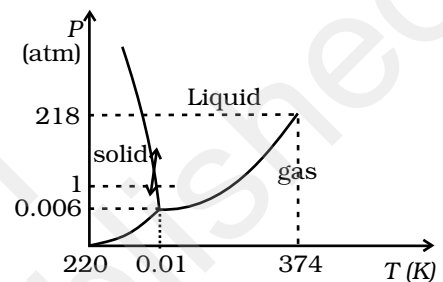

**11.20** Resultant mixture reaches 0°C. 12.5 g of ice and rest is water.

**11.21** The first option would have kept water warmer because according to Newton's law of cooling, the rate of loss of heat is directly proportional to the difference of temperature of the body and the surrounding and in the first case the temperature difference is less, so rate of loss of heat will be less.

**11.22**  $l_{iron} - l_{brass} = 10\text{cm}$  at all temperature  
 $\therefore l_{iron}^{\circ} (1 + \alpha_{iron} \Delta t) - l_{brass}^{\circ} (1 + \alpha_{brass} \Delta t) = 10\text{cm}$

$$l_{iron}^{\circ} \alpha_{iron} = l_{brass}^{\circ} \alpha_{brass}$$

$$\therefore \frac{l_{iron}^{\circ}}{l_{brass}^{\circ}} = \frac{1.8}{1.2} = \frac{3}{2}$$

$$\therefore \frac{1}{2} l_{brass}^{\circ} = 10\text{cm} \Rightarrow l_{brass}^{\circ} = 20\text{ cm}$$

and  $l_{iron}^{\circ} = 30\text{ cm}$

**11.23** Iron vessel with a brass rod inside

$$\frac{V_{\text{iron}}}{V_{\text{brass}}} = \frac{6}{3.55}$$

$$V_{\text{iron}} - V_{\text{brass}} = 100\text{cc} = V_0$$

$$V_{\text{brass}}^{\text{rod}} = 144.9\text{cc} \quad V_{\text{iron}}^{\text{inside}} = 244.9\text{cc}$$

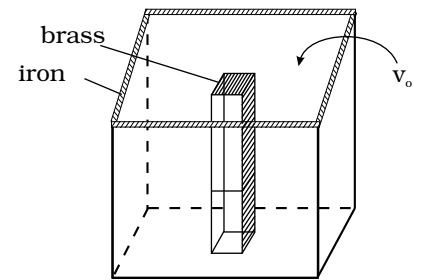

**11.24** Stress =  $K \times$  strain

$$= K \frac{\Delta V}{V}$$

$$= K(3\alpha)\Delta t$$

$$= 140 \times 10^9 \times 3 \times 1.7 \times 10^{-5} \times 20$$

$$= 1.428 \times 10^8 \text{ N/m}^2$$

This is about  $10^3$  times atmospheric pressure.

**11.25**  $x = \sqrt{\left(\frac{L}{2} + \frac{\Delta L}{2}\right)^2 - \left(\frac{L}{2}\right)^2}$

$$\approx \frac{1}{2} \sqrt{2L \Delta L}$$

$$\Delta L = \alpha L \Delta t$$

$$\therefore x \approx \frac{L}{2} \sqrt{2\alpha \Delta t}$$

$$\approx 0.11\text{m} \rightarrow 11\text{cm}$$

**11.26 Method I**

Temperature  $\theta$  at a distance  $x$  from one end (that at  $\theta_1$ ) is given by

$$\theta = \theta_1 + \frac{x}{L_0}(\theta_2 - \theta_1) : \text{linear temperature gradient.}$$

New length of small element of length  $dx_0$

$$dx = dx_0 (1 + \alpha\theta)$$

$$= dx_0 + dx_0 \alpha \left[ \theta_1 + \frac{x}{L_0}(\theta_2 - \theta_1) \right]$$

Now  $\int dx_0 = L_0$  and  $\int dx = L$  : new length

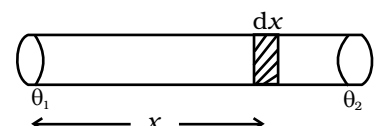



Integrating

$$\begin{aligned} \therefore L &= L_o + L_o \alpha \theta_1 + \frac{(\theta_2 - \theta_1)}{L_o} \alpha \int x \, dx_o \\ &= L_o \left( 1 + \frac{1}{2} \alpha (\theta_2 + \theta_1) \right) \text{ as } \int_0^{L_o} x dx = \frac{1}{2} L_o^2 \end{aligned}$$

### Method II

If temperature of the rod varies linearly, we can assume average temperature to be  $\frac{1}{2}(\theta_1 + \theta_2)$  and hence new length

$$L = L_o \left( 1 + \frac{1}{2} \alpha (\theta_2 + \theta_1) \right)$$

**11.27** (i)  $1.8 \times 10^{17}$  J/S      (ii)  $7 \times 10^9$  kg

(iii)  $47.7$  N/m<sup>2</sup>.

## Chapter 12

**12.1** (c) adiabatic

A is isobaric process, D is isochoric. Of B and C, B has the smaller slope (magnitude) hence is isothermal. Remaining process is adiabatic.

**12.2** (a)

**12.3** (c)

**12.4** (b)

**12.5** (a)

**12.6** (b)

**12.7** (a), (b) and (d).

**12.8** (a), (d)

**12.9** (b), (c)

**12.10** (a), (c)

**12.11** (a), (c)

**12.12** If the system does work against the surroundings so that it compensates for the heat supplied, the temperature can remain constant.

**12.13**  $U_p - U_Q = \text{W.D. in path 1 on the system} + 1000 \text{ J}$   
 $= \text{W.D. in path 2 on the system} + Q$

$$Q = (-100 + 1000) \text{ J} = 900 \text{ J}$$

**12.14** Here heat removed is less than the heat supplied and hence the room, including the refrigerator (which is not insulated from the room) becomes hotter.

**12.15** Yes. When the gas undergoes adiabatic compression, its temperature increases.

$$dQ = dU + dW$$

As  $dQ = 0$  (adiabatic process)

$$\text{so } dU = -dW$$

In compression, work is done on the system So,  $dW = -ve$

$$\Rightarrow dU = +ve$$

So internal energy of the gas increases, i.e. its temperature increases.

**12.16** During driving, temperature of the gas increases while its volume remains constant.

So according to Charle's law, at constant  $V$ ,  $P \propto T$ .

Therefore, pressure of gas increases.

**12.17**  $\frac{Q}{Q_1} = \frac{T_2}{T_1} = \frac{3}{5}$ ,  $Q_1 - Q_2 = 10^3 \text{ J}$

$$Q_1 \left(1 - \frac{3}{5}\right) = 10^3 \text{ J} \Rightarrow Q_1 = \frac{5}{2} \times 10^3 \text{ J} = 2500 \text{ J}, Q_2 = 1500 \text{ J}$$

**12.18**  $5 \times 7000 \times 10^3 \times 4.2 \text{ J} = 60 \times 15 \times 10 \times N$

$$N = \frac{21 \times 7 \times 10^6}{900} = \frac{147}{9} \times 10^3 = 16.3 \times 10^3 \text{ times.}$$

**12.19**  $P(V + \Delta v)^\gamma = (P + \Delta p)V^\gamma$

$$P \left[ 1 + \gamma \frac{\Delta v}{V} \right] = P \left( 1 + \frac{\Delta p}{P} \right)$$

$$\gamma \frac{\Delta v}{V} = \frac{\Delta p}{P}; \frac{dv}{dp} = \frac{V}{\gamma P}$$

$$\text{W.D.} = \int_{P_1}^{P_2} p \, dv = \int_{P_1}^{P_2} p \frac{V}{\gamma p} dp = \frac{(P_2 - P_1)}{\gamma} V$$

**12.20**  $\eta = 1 - \frac{270}{300} = \frac{1}{10}$

Efficiency of refrigerator =  $0.5\eta = \frac{1}{20}$

If  $Q$  is the heat/s transferred at higher temperature then  $\frac{W}{Q} = \frac{1}{20}$   
or  $Q = 20W = 20 \text{ kJ}$ ,

and heat removed from lower temperature =  $19 \text{ kJ}$ .

**12.21**  $\frac{Q_2}{W} = 5, Q_2 = 5W, Q_1 = 6W$

$$\frac{T_2}{T_1} = \frac{5}{6} = \frac{T}{300}, T_2 = 250 \text{ K} = -23^\circ \text{C}$$

**12.22** The  $P$ - $V$  diagram for each case is shown in the figure. In case (i)  $P_1 V_1 = P_f V_f$ ; therefore process is isothermal. Work done = area under the  $PV$  curve so work done is more when the gas expands at constant pressure.

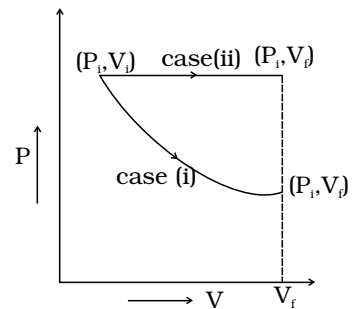

**12.23** (a) Work done by the gas (Let  $PV^{1/2} = A$ )

$$\begin{aligned} \Delta W &= \int_{V_1}^{V_2} p \, dv = A \int_{V_1}^{V_2} \frac{dV}{\sqrt{V}} = A \left[ \frac{\sqrt{V}}{1/2} \right]_{V_1}^{V_2} = 2A(\sqrt{V_2} - \sqrt{V_1}) \\ &= 2P_1 V_1^{1/2} [V_2^{1/2} - V_1^{1/2}] \end{aligned}$$

(b) Since  $T = pV / nR = \frac{A}{nR} \cdot \sqrt{V}$

Thus,  $\frac{T_2}{T_1} = \sqrt{\frac{V_2}{V_1}} = \sqrt{2}$

(c) Then, the change in internal energy

$$\Delta U = U_2 - W_1 = \frac{3}{2} R(T_2 - T_1) = \frac{3}{2} RT_1 (\sqrt{2} - 1)$$

$$\Delta W = 2A\sqrt{V_1}(\sqrt{2} - 1) = 2RT_1(\sqrt{2} - 1)$$

$$\Delta Q = (7/2)RT_1(\sqrt{2} - 1)$$

12.24 (a) A to B

(b) C to D

(c)  $W_{AB} = \int_A^B p dV = 0; W_{CD} = 0.$

Similarly,  $W_{BC} = \left[ \int_B^C p dV = k \int_B^C \frac{dV}{V^\gamma} = k \frac{V^{-\gamma+1}}{-\gamma+1} \right]_{V_B}^{V_C}$

$$= \frac{1}{1-\gamma} (P_C V_C - P_B V_B)$$

Similarly,  $W_{DA} = \frac{1}{1-\gamma} (P_A V_A - P_D V_D)$

Now  $P_C = P_B \left( \frac{V_B}{V_C} \right)^\gamma = 2^{-\gamma} P_B$

Similarly,  $P_D = P_A 2^{-\gamma}$

Total work done =  $W_{BC} + W_{DA}$

$$= \frac{1}{1-\gamma} [P_B V_B (2^{-\gamma+1} - 1) - P_A V_A (2^{-\gamma+1} - 1)]$$

$$= \frac{1}{1-\gamma} (2^{1-\gamma} - 1)(P_B - P_A)V_A$$

$$= \frac{3}{2} \left( 1 - \left( \frac{1}{2} \right)^{2/3} \right) (P_B - P_A)V_A$$

(d) Heat supplied during process A, B

$$dQ_{AB} = dU_{AB}$$

$$Q_{AB} = \frac{3}{2} nR(T_B - T_A) = \frac{3}{2} (P_B - P_A)V_A$$

$$\text{Efficiency} = \frac{\text{Net Work done}}{\text{Heat Supplied}} = \left[ 1 - \left( \frac{1}{2} \right)^{2/3} \right]$$

12.25  $Q_{AB} = U_{AB} = \frac{3}{2} R(T_B - T_A) = \frac{3}{2} V_A(P_B - P_A)$

$$Q_{BC} = U_{BC} + W_{BC}$$

$$= (3/2) P_B(V_C - V_B) + P_B(V_C - V_B)$$

$$= (5/2) P_B(V_C - V_A)$$

$$Q_{CA} = 0$$

$$Q_{DA} = (5/2) P_A (V_A - V_D)$$

**12.26** Slope of  $P = f(V)$ , curve at  $(V_o, P_o)$

$$= f'(V_o)$$

Slope of adiabat at  $(V_o, P_o)$

$$= k(-\gamma) V_o^{-1-\gamma} = -\gamma P_o/V_o$$

Now heat absorbed in the process  $P = f(V)$

$$dQ = dV + dW$$

$$= nC_v dT + P dV$$

Since  $T = (1/nR) PV = (1/nR) V f(V)$

$$dT = (1/nR) [f(V) + V f'(V)] dV$$

Thus

$$\frac{dQ}{dV} \Big|_{V=V_o} = \frac{CV}{R} [f(V_o) + V_o f'(V_o)] + f(V_o)$$

$$= \left[ \frac{1}{\gamma-1} + 1 \right] f(V_o) + \frac{V_o f'(V_o)}{\gamma-1}$$

$$= \frac{\gamma}{\gamma-1} P_o + \frac{V_o}{\gamma-1} f'(V_o)$$

Heat is absorbed when  $dQ/dV > 0$  when gas expands, that is when

$$\gamma P_o + V_o f'(V_o) > 0$$

$$f'(V_o) > -\gamma P_o/V_o$$

**12.27** (a)  $P_i = P_a$

(b)  $P_f = P_a + \frac{k}{A}(V - V_o) = P_a + k(V - V_o)$

(c) All the supplied heat is converted to mechanical energy. No change in internal energy (Perfect gas)

$$\Delta Q = P_a(V - V_o) + \frac{1}{2}k(V - V_o)^2 + C_V(T - T_o)$$

where  $T_o = P_a V_o/R$ ,

$$T = [P_a + (R/A)(V - V_o)]V/R$$

## Chapter 13

13.1 (b)

*Comment for discussion:* This brings in concepts of relative motion and that when collision takes place, it is the relative velocity which changes.

13.2 (d)

*Comment for discussion:* In the ideal case that we normally consider, each collision transfers twice the magnitude of its normal momentum. On the face EFGH, it transfers only half of that.

13.3 (b)

13.4 (c) This is a constant pressure ( $p = Mg/A$ ) arrangement.

13.5 (a)

13.6 (d)

*Comment for discussion:* The usual statement for the perfect gas law somehow emphasizes molecules. If a gas exists in atomic form (perfectly possible) or a combination of atomic and molecular form, the law is not clearly stated.

13.7 (b)

*Comment:* In a mixture, the average kinetic energy are equating. Hence, distribution in velocity are quite different.

13.8 (d)

*Comment for discussion:* In this chapter, one has discussed constant pressure and constant volume situations but in real life there are many situations where both change. If the surfaces were rigid,  $p$  would rise to 1.1  $p$ . However, as the pressure rises,  $V$  also rises such that  $pV$  finally is 1.1  $RT$  with  $p_{\text{final}} > p$  and  $V_{\text{final}} > V$ . Hence (d).

13.9 (b),(d)

13.10 (c)

13.11 (a), (d)

*Comment* : The equation <K.E. of translation> =  $\left(\frac{3}{2}\right)RT$ , <Rotational energy> =  $RT$  is taught. The fact that the distribution of the two is independent of each other is not emphasized. They are independently Maxwellian.

**13.12** (a), (c)

**13.13** (a)

*Comment* : Conceptually, it is not often clear to the students that elastic collisions with a moving object leads to change in its energy.

**13.14**  $\therefore$  Molar mass of gold is  $197 \text{ g mole}^{-1}$ , the number of atoms =  $6.0 \times 10^{23}$

$$\therefore \text{No. of atoms in } 39.4\text{g} = \frac{6.0 \times 10^{23} \times 39.4}{197} = 1.2 \times 10^{23}$$

**13.15** Keeping  $P$  constant, we have

$$V_2 = \frac{V_1 T_2}{T_1} = \frac{100 \times 600}{300} = 200\text{cc}$$

**13.16**  $\frac{P_1 V_1}{T_1} = \frac{P_2 V_2}{T_2}$

$$\frac{V_1}{V_2} = \frac{P_2 T_1}{P_1 T_2} = \frac{2 \times 300}{400} = \frac{3}{2}$$

$$P_1 = \frac{1}{3} \frac{M}{V_1} c_1^{-2}; \quad P_2 = \frac{1}{3} \frac{M}{V_2} c_2^{-2}$$

$$\begin{aligned} \therefore c_2^2 &= c_1^2 \times \frac{V_2}{V_1} \times \frac{P_2}{P_1} \\ &= (100)^2 \times \frac{2}{3} \times 2 \end{aligned}$$

$$c_2 = \frac{200}{\sqrt{3}} \text{ m s}^{-1}$$

**13.17**  $v_{rms} = \sqrt{\frac{v_1^2 + v_2^2}{2}}$

$$\begin{aligned} &= \sqrt{\frac{(9 \times 10^6)^2 + (1 \times 10^6)^2}{2}} \\ &= \sqrt{\frac{(81 + 1) \times 10^{12}}{2}} = \sqrt{41} \times 10^6 \text{ m s}^{-1}. \end{aligned}$$

**13.18**  $\text{O}_2$  has 5 degrees of freedom. Therefore, energy per mole =  $\frac{5}{2}RT$

$\therefore$  For 2 moles of  $\text{O}_2$ , energy =  $5RT$

Neon has 3 degrees of freedom  $\therefore$  Energy per mole =  $\frac{3}{2}RT$

$\therefore$  For 4 mole of neon, energy =  $4 \times \frac{3}{2}RT = 6RT$

$\therefore$  Total energy =  $11RT$ .

$$13.19 \quad l \propto \frac{1}{d^2}$$

$$d_1 = 1 \text{ \AA} \quad \alpha_2 = 2 \text{ \AA}$$

$$l_1 : l_2 = 4 : 1$$

$$13.20 \quad V_1 = 2.0 \text{ litre} \quad V_2 = 3.0 \text{ litre}$$

$$\mu_1 = 4.0 \text{ moles} \quad \mu_2 = 5.0 \text{ moles}$$

$$P_1 = 1.00 \text{ atm} \quad P_2 = 2.00 \text{ atm}$$

$$P_1 V_1 = \mu_1 R T_1 \quad P_2 V_2 = \mu_2 R T_2$$

$$\mu = \mu_1 + \mu_2 \quad V = V_1 + V_2$$

$$\text{For 1 mole } PV = \frac{2}{3} E$$

$$\text{For } \mu_1 \text{ moles } P_1 V_1 = \frac{2}{3} \mu_1 E_1$$

$$\text{For } \mu_2 \text{ moles } P_2 V_2 = \frac{2}{3} \mu_2 E_2$$

$$\text{Total energy is } (\mu_1 E_1 + \mu_2 E_2) = \frac{3}{2} (P_1 V_1 + P_2 V_2)$$

$$PV = \frac{2}{3} E_{\text{total}} = \frac{2}{3} \mu E_{\text{per mole}}$$

$$P(V_1 + V_2) = \frac{2}{3} \times \frac{3}{2} (P_1 V_1 + P_2 V_2)$$

$$P = \frac{P_1 V_1 + P_2 V_2}{V_1 + V_2} \quad *$$

$$= \left( \frac{1.00 \times 2.0 + 2.00 \times 3.0}{2.0 + 3.0} \right) \text{ atm}$$

$$= \frac{8.0}{5.0} = 1.60 \text{ atm.}$$

*Comment:* This form of ideal gas law represented by Equation marked\* becomes very useful for adiabatic changes.

13.21 The average K.E will be the same as conditions of temperature and pressure are the same

$$v_{\text{rms}} \propto \frac{1}{\sqrt{m}}$$

$$\therefore m_A > m_B > m_C$$

$$v_C > v_B > v_A$$



**13.22** We have  $0.25 \times 6 \times 10^{23}$  molecules, each of volume  $10^{-30} \text{m}^3$ .

Molecular volume =  $2.5 \times 10^{-7} \text{m}^3$

Supposing Ideal gas law is valid.

$$\text{Final volume} = \frac{V_{in}}{100} = \frac{(3)^3 \times 10^{-6}}{100} \approx 2.7 \times 10^{-7} \text{m}^3$$

which is about the molecular volume. Hence, intermolecular forces cannot be neglected. Therefore the ideal gas situation does not hold.

**13.23** When air is pumped, more molecules are pumped in. Boyle's law is stated for situation where number of molecules remain constant.

**13.24**  $\mu = 5.0$

$T = 280 \text{K}$

No of atoms =  $\mu N_A = 5.0 \times 6.02 \times 10^{23}$

$$= 30 \times 10^{23}$$

Average kinetic energy per molecule =  $\frac{3}{2} kT$

$$\begin{aligned} \therefore \text{Total internal energy} &= \frac{3}{2} kT \times N \\ &= \frac{3}{2} \times 30 \times 10^{23} \times 1.38 \times 10^{-23} \times 280 \\ &= 1.74 \times 10^4 \text{ J} \end{aligned}$$

**13.25** Volume occupied by 1 gram mole of gas at NTP = 22400cc

$\therefore$  Number of molecules in 1cc of hydrogen

$$= \frac{6.023 \times 10^{23}}{22400} = 2.688 \times 10^{19}$$

As each diatomic molecule has 5 degrees of freedom, hydrogen being diatomic also has 5 degrees of freedom

$$\begin{aligned} \therefore \text{Total no of degrees of freedom} &= 5 \times 2.688 \times 10^{19} \\ &= 1.344 \times 10^{20} \end{aligned}$$

**13.26** Loss in K.E of the gas =  $\Delta E = \frac{1}{2} (mn)v_o^2$

where  $n =$  no: of moles.

If its temperature changes by  $\Delta T$ , then

$$n \frac{3}{2} R \Delta T = \frac{1}{2} mn v_o^2 \quad \therefore \Delta T = \frac{mv_o^2}{3R}$$

**13.27** The moon has small gravitational force and hence the escape velocity is small. As the moon is in the proximity of the Earth as seen from the Sun, the moon has the same amount of heat per unit area as that of the Earth. The air molecules have large range of speeds. Even though the rms speed of the air molecules is smaller than the escape velocity on the moon, a significant number of molecules have speed greater than escape velocity and they escape. Now rest of the molecules arrange the speed distribution for the equilibrium temperature. Again a significant number of molecules escape as their speeds exceed escape speed. Hence, over a long time the moon has lost most of its atmosphere.

$$\text{At } 300 \text{ K} \quad V_{rms} = \sqrt{\frac{3kT}{m}} = \sqrt{\frac{3 \times 1.38 \times 10^{-23} \times 300}{7.3 \times 10^{-26}}} = 1.7 \text{ km/s}$$

$$V_{esc} \text{ for moon} = 4.6 \text{ km/s}$$

(b) As the molecules move higher their potential energy increases and hence kinetic energy decreases and hence temperature reduces.

At greater height more volume is available and gas expands and hence some cooling takes place.

**13.28** (This problem is designed to give an idea about cooling by evaporation)

(i)

$$\begin{aligned} V_{rms}^2 &= \frac{\sum_i n_i v_i^2}{\sum_i n_i} \\ &= \frac{10 \times (200)^2 + 20 \times (400)^2 + 40 \times (600)^2 + 20 \times (800)^2 + 10 \times (1000)^2}{100} \\ &= \frac{10 \times 100^2 \times (1 \times 4 + 2 \times 16 + 4 \times 36 + 2 \times 64 + 1 \times 100)}{100} \\ &= 1000 \times (4 + 32 + 144 + 128 + 100) = 408 \times 1000 \text{ m}^2/\text{s}^2 \end{aligned}$$

$$\therefore v_{rms} = 639 \text{ m/s}$$

$$\frac{1}{2} m v_{rms}^2 = \frac{3}{2} kT$$

$$\therefore T = \frac{1}{3} \frac{m v_{rms}^2}{k} = \frac{1}{3} \times \frac{3.0 \times 10^{-26} \times 4.08 \times 10^5}{1.38 \times 10^{-23}}$$

$$= 2.96 \times 10^2 \text{ K} = 296 \text{ K}$$

$$\begin{aligned}
 \text{(ii) } V_{rms}^2 &= \frac{10 \times (200)^2 + 20 \times (400)^2 + 40 \times (600)^2 + 20 \times (800)^2}{90} \\
 &= \frac{10 \times 100^2 \times (1 \times 4 + 2 \times 16 + 4 \times 36 + 2 \times 64)}{90} \\
 &= 10000 \times \frac{308}{9} = 342 \times 1000 \text{ m}^2/\text{s}^2
 \end{aligned}$$

$$v_{rms} = 584 \text{ m/s}$$

$$T = \frac{1}{3} \frac{mV_{rms}^2}{k} = 248 \text{ K}$$

**13.29** Time  $t = \frac{\lambda}{v}$

$$\lambda = \frac{1}{\sqrt{2}\pi d^2 n}, \text{ } d = \text{diameter and } n = \text{number density}$$

$$n = \frac{N}{V} = \frac{10}{20 \times 20 \times 1.5} = 0.0167 \text{ km}^{-3}$$

$$\begin{aligned}
 t &= \frac{1}{\sqrt{2}\pi d^2 (N/V) \times v} \\
 &= \frac{1}{1.414 \times 3.14 \times (20)^2 \times 0.0167 \times 10^{-3} \times 150}
 \end{aligned}$$

$$= 225 \text{ h}$$

**13.30**  $V_{1x}$  = speed of molecule inside the box along  $x$  direction

$n_1$  = number of molecules per unit volume

In time  $\Delta t$ , particles moving along the wall will collide if they are within  $(V_{1x}\Delta t)$  distance. Let  $a$  = area of the wall. No. of particles colliding in time  $\Delta t = \frac{1}{2}n_1(V_{1x}\Delta t)a$  (factor of  $1/2$  due to motion towards wall).

In general, gas is in equilibrium as the wall is very large as compared to hole.

$$\therefore V_{1x}^2 + V_{1y}^2 + V_{1z}^2 = V_{rms}^2$$

$$\therefore V_{1x}^2 = \frac{V_{rms}^2}{3}$$

$$\frac{1}{2}mV_{rms}^2 = \frac{3}{2}kT \Rightarrow V_{rms}^2 = \frac{3kT}{m}$$

$$\therefore V_{1x}^2 = \frac{kT}{m}$$

$$\therefore \text{No. of particles colliding in time } \Delta t = \frac{1}{2}n_1\sqrt{\frac{kT}{m}}\Delta t a. \text{ If particles}$$

collide along hole, they move out. Similarly outer particles colliding along hole will move in.

∴ Net particle flow in time  $\Delta t = \frac{1}{2}(n_1 - n_2)\sqrt{\frac{kT}{m}}\Delta t a$  as temperature is same in and out.

$$pV = \mu RT \Rightarrow \mu = \frac{pV}{RT}$$

$$n = \frac{\mu N_A}{V} = \frac{PN_A}{RT}$$

After some time  $\tau$  pressure changes to  $p_1'$  inside

$$\therefore n_1' = \frac{P_1' N_A}{RT}$$

$$n_1 V - n_1' V = \text{no. of particle gone out} = \frac{1}{2}(n_1 - n_2)\sqrt{\frac{kT}{m}}\tau a$$

$$\therefore \frac{P_1 N_A}{RT} V - \frac{P_1' N_A}{RT} V = \frac{1}{2}(P_1 - P_2) \frac{N_A}{RT} \sqrt{\frac{kT}{m}}\tau a$$

$$\therefore \tau = 2 \left( \frac{P_1 - P_1'}{P_1 - P_2} \right) \frac{V}{a} \sqrt{\frac{m}{kT}}$$

$$= 2 \left( \frac{1.5 - 1.4}{1.5 - 1.0} \right) \frac{5 \times 1.00}{0.01 \times 10^{-6}} \sqrt{\frac{46.7 \times 10^{-27}}{1.38 \times 10^{-23} \times 300}}$$

$$= 1.38 \times 10^5 \text{ s}$$

**13.31**  $n$  = no. of molecules per unit volume

$v_{\text{rms}}$  = rms speed of gas molecules

When block is moving with speed  $v_o$ , relative speed of molecules w.r.t.

front face =  $v + v_o$

Coming head on, momentum transferred to block per collision

$$= 2m(v + v_o), \text{ where } m = \text{mass of molecule.}$$

No. of collision in time  $\Delta t = \frac{1}{2}(v + v_o)n\Delta tA$ , where  $A$  = area of cross section of block and factor of  $1/2$  appears due to particles moving towards block.

∴ Momentum transferred in time  $\Delta t = m(v + v_o)^2 nA\Delta t$  from front surface

Similarly momentum transferred in time  $\Delta t = m(v - v_o)^2 nA\Delta t$  from back surface

$$\therefore \text{Net force (drag force)} = mnA[(v + v_o) - (v - v_o)^2] \text{ from front}$$

$$= mnA(4vv_o) = (4mnAv)v_o$$

$$= (4\rho Av)v_o$$

We also have  $\frac{1}{2}mv^2 = \frac{1}{2}kT$  ( $v$  - is the velocity along  $x$ -axis)

Therefore,  $v = \sqrt{\frac{kT}{m}}$ .

Thus drag  $= 4\rho A\sqrt{\frac{kT}{m}}v_0$ .

## Chapter 14

- 14.1 (b)  
 14.2 (b)  
 14.3 (d)  
 14.4 (c)  
 14.5 (c)  
 14.6 (d)  
 14.7 (b)  
 14.8 (a)  
 14.9 (c)  
 14.10 (a)  
 14.11 (b)  
 14.12 (a), (c)  
 14.13 (a), (c)  
 14.14 (d), (b)  
 14.15 (a), (b), (d)  
 14.16 (a), (b), (c)  
 14.17 (a), (b) (d)  
 14.18 (a), (c), (d)  
 14.19 (i) (A),(C),(E),(G) (ii) (B), (D), (F), (H)  
 14.20  $2kx$  towards left.  
 14.21 (a) Acceleration is directly proportional to displacement.  
 (b) Acceleration is directed opposite to displacement.  
 14.22 When the bob of the pendulum is displaced from the mean position so that  $\sin\theta \cong \theta$

14.23  $+\omega$

14.24 Four

14.25 -ve

14.27

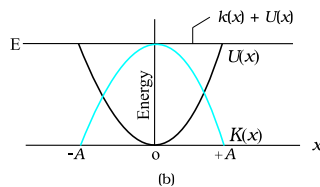

14.28  $l_m = \frac{1}{6} l_E = \frac{1}{6} m$

14.29 If mass  $m$  moves down by  $h$ , then the spring extends by  $2h$  (because each side expands by  $h$ ). The tension along the string and spring is the same.

In equilibrium

$$mg = 2(k \cdot 2h)$$

where  $k$  is the spring constant.

On pulling the mass down by  $x$ ,

$$F = mg - 2k(2h + 2x)$$

$$= -4kx$$

So,  $T = 2\pi\sqrt{\frac{m}{4k}}$

14.30  $y = \sqrt{2} \sin(\omega t - \pi/4); T = 2\pi/\omega$

14.31  $\frac{A}{\sqrt{2}}$

14.32  $U = U_0(1 - \cos \alpha x)$

$$F = \frac{-dU}{dx} = \frac{-d}{dx}(U_0 - U_0 \cos \alpha x)$$

$$= -U_0 \alpha \sin \alpha x$$

$$\approx -U_0 \alpha \alpha x \quad (\text{for small } \alpha x, \sin \alpha x \sim \alpha x)$$

$$= -U_0 \alpha^2 x$$

We know that  $F = -kx$

So,  $k = U_0 \alpha^2$

$$T = 2\pi\sqrt{\frac{m}{U_0 \alpha^2}}$$

**14.33**  $x = 5 \sin 5t$ .

**14.34**  $\theta_1 = \theta_o \sin(\omega t + \delta_1)$

$\theta_2 = \theta_o \sin(\omega t + \delta_2)$

For the first,  $\theta = 2^\circ, \therefore \sin(\omega t + \delta_1) = 1$

For the 2nd,  $\theta = -1^\circ, \therefore \sin(\omega t + \delta_2) = -1/2$

$\therefore \omega t + \delta_1 = 90^\circ, \omega t + \delta_2 = -30^\circ$

$\therefore \delta_1 - \delta_2 = 120^\circ$

**14.35** (a) Yes.

(b) Maximum weight =  $Mg + MA\omega^2$

$= 50 \times 9.8 + 50 \times \frac{5}{100} \times (2\pi \times 2)^2$

$= 490 + 400 = 890\text{N}.$

Minimum weight =  $Mg - MA\omega^2$

$= 50 \times 9.8 - 50 \times \frac{5}{100} \times (2\pi \times 2)^2$

$= 490 - 400$

$= 90\text{ N}.$

Maximum weight is at the topmost position,

Minimum weight is at the lowermost position.

**14.36** (a) 2cm (b)  $2.8\text{ s}^{-1}$

**14.37** Let the log be pressed and let the vertical displacement at the equilibrium position be  $x_o$ .

At equilibrium

$mg = \text{Buoyant force}$

$= Ax_o\rho g$

When it is displaced by a further displacement  $x$ , the buoyant force is  $A(x_o + x)\rho g$ .

Net restoring force

$= \text{Buoyant force} - \text{weight}$

$= A(x_o + x)\rho g - mg$

$= (A\rho g)x$  . i.e. proportional to  $x$ .

$\therefore T = 2\pi \sqrt{\frac{m}{A\rho g}}$

**14.38** Consider the liquid in the length  $dx$ . It's mass is  $A\rho dx$  at a height  $x$ .

$$PE = A\rho dx gx$$

The PE of the left column

$$= \int_0^{h_1} A\rho g x dx$$

$$= A\rho g \frac{x^2}{2} \Big|_0^{h_1} = A\rho g \frac{h_1^2}{2} = \frac{A\rho g l^2 \sin^2 45^\circ}{2}$$

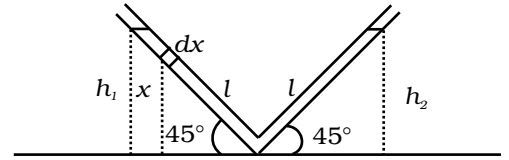

Similarly, P.E. of the right column  $= A\rho g \frac{h_2^2}{2} = \frac{A\rho g l^2 \sin^2 45^\circ}{2}$

$h_1 = h_2 = l \sin 45^\circ$  where  $l$  is the length of the liquid in one arm of the tube.

$$\text{Total P.E.} = A\rho g h^2 = A\rho g l^2 \sin^2 45^\circ = \frac{A\rho g l^2}{2}$$

If the change in liquid level along the tube in left side is  $y$ , then length of the liquid in left side is  $l-y$  and in the right side is  $l+y$ .

$$\text{Total P.E.} = A\rho g(l-y)^2 \sin^2 45^\circ + A\rho g(l+y)^2 \sin^2 45^\circ$$

$$\text{Change in PE} = (PE)_f - (PE)_i$$

$$= \frac{A\rho g}{2} [(l-y)^2 + (l+y)^2 - l^2]$$

$$= \frac{A\rho g}{2} [l^2 + y^2 - 2ly + l^2 + y^2 + 2ly - l^2]$$

$$= A\rho g [y^2 + l^2]$$

$$\text{Change in K.E.} = \frac{1}{2} A\rho 2ly^2$$

$$\text{Change in total energy} = 0$$

$$\Delta(P.E) + \Delta(K.E) = 0$$

$$A\rho g [l^2 + y^2] + A\rho ly^2 = 0$$

Differentiating both sides w.r.t. time,



$$A\rho g \left[ 0 + 2y \frac{dy}{dt} \right] + 2A\rho l \ddot{y} = 0$$

$$2A\rho g y + 2A\rho l \ddot{y} = 0$$

$$l \ddot{y} + g y = 0$$

$$\ddot{y} + \frac{g}{l} y = 0$$

$$\omega^2 = \frac{g}{l}$$

$$\omega = \sqrt{\frac{g}{l}}$$

$$T = 2\pi \sqrt{\frac{l}{g}}$$

- 14.39** Acceleration due to gravity at  $P = \frac{g \cdot x}{R}$ , where  $g$  is the acceleration at the surface.

$$\text{Force} = \frac{mgx}{R} = -k \cdot x, \quad k = \frac{mg}{R}$$

$$\text{Motion will be SHM with time period } T = \sqrt{\frac{m}{K}} = 2\pi \sqrt{\frac{R}{g}}$$

- 14.40** Assume that  $t = 0$  when  $\theta = \theta_0$ . Then,

$$\theta = \theta_0 \cos \omega t$$

Given a seconds pendulum  $\omega = 2\pi$

At time  $t_1$ , let  $\theta = \theta_0/2$

$$\therefore \cos 2\pi t_1 = 1/2 \Rightarrow t_1 = \frac{1}{6}$$

$$\dot{\theta} = -\theta_0 2\pi \sin 2\pi t \quad \left[ \dot{\theta} = \frac{d\theta}{dt} \right]$$

At  $t_1 = 1/6$

$$\dot{\theta} = -\theta_0 2\pi \sin \frac{2\pi}{6} = -\sqrt{3}\pi\theta_0$$

Thus the linear velocity is

$$u = -\sqrt{3}\pi\theta_0 l \quad \text{perpendicular to the string.}$$

The vertical component is

$$u_y = -\sqrt{3}\pi\theta_0 l \sin \theta_0$$

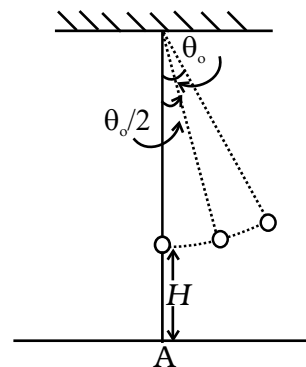

and the horizontal component is

$$u_x = -\sqrt{3}\pi\theta_0 l \cos \theta_0$$

At the time it snaps, the vertical height is

$$H' = H + l(1 - \cos(\theta_0 / 2))$$

Let the time required for fall be  $t$ , then

$$H' = u_y t + (1/2)gt^2 \quad (\text{notice } g \text{ is also in the negative direction})$$

$$\text{Or, } \frac{1}{2}gt^2 + \sqrt{3}\pi\theta_0 l \sin \theta_0 t - H' = 0$$

$$\begin{aligned} \therefore t &= \frac{-\sqrt{3}\pi\theta_0 l \sin \theta_0 \pm \sqrt{3\pi^2\theta_0^2 l^2 \sin^2 \theta_0 + 2gH'}}{g} \\ &= \frac{-\sqrt{3}\pi l \theta_0^2 \pm \sqrt{3\pi^2\theta_0^4 l^2 + 2gH'}}{g} \end{aligned}$$

Neglecting terms of order  $\theta_0^2$  and heigher,

$$t \approx \sqrt{\frac{2H'}{g}}$$

$$\text{Now } H' \approx H + l(1 - 1) = H \therefore t \approx \sqrt{\frac{2H}{g}}$$

The distance travelled in the  $x$  direction is  $u_x t$  to the left of where it snapped.

$$X = \sqrt{3}\pi\theta_0 l \cos \theta_0 \sqrt{\frac{2H}{g}}$$

To order of  $\theta_0$ ,

$$X = \sqrt{3}\pi\theta_0 l \sqrt{\frac{2H}{g}} = \sqrt{\frac{6H}{g}}\theta_0 l.$$

At the time of snapping, the bob was

$$l \sin \theta_0 \approx l\theta_0 \text{ distance from A.}$$

Thus, the distance from A is

$$l\theta_0 - \sqrt{\frac{6H}{g}}l\theta_0 = l\theta_0 (1 - \sqrt{6H/g}).$$

## Chapter 15

- 15.1 (b)  
 15.2 (c)  
 15.3 (c)  
 15.4 (c)  
 15.5 (b)  
 15.6 (c)  
 15.7 (d)  
 15.8 (b)  
 15.9 (b)  
 15.10 (c)  
 15.11 (a), (b), (c)  
 15.12 (b), (c)  
 15.13 (c), (d)  
 15.14 (b), (c), (d)  
 15.15 (a), (b), (d)  
 15.16 (a), (b)  
 15.17 (a), (b), (d), (e)  
 15.18 Wire of twice the length vibrates in its second harmonic. Thus if the tuning fork resonates at  $L$ , it will resonate at  $2L$ .  
 15.19  $L/2$  as  $\lambda$  is constant.  
 15.20 517 Hz.  
 15.21 5cm  
 15.22  $1/3$ . Since frequency  $\propto \sqrt{\frac{1}{m}}$   $m = \pi r^2 \rho$   
 15.23  $2184^\circ\text{C}$ , since  $C \propto \sqrt{T}$   
 15.24  $\frac{1}{n_1 - n_2}$   
 15.25  $343 \text{ m s}^{-1}$ .  $\left[ n = \frac{1}{2l} \sqrt{\frac{T}{m}} \right]$   
 15.26 3rd harmonic  $\left[ \text{since } n_o = \frac{v}{4l} = 412.5 \text{ with } v = 330 \text{ m/s} \right]$   
 15.27  $412.5 \text{ Hz}$   $\left[ n' = n \left( \frac{c}{c - v} \right) \right]$

**15.28** Stationary waves; 20cm

**15.29** (a)  $9.8 \times 10^{-4}$ s. (b) Nodes-A, B, C, D, E. Antinodes-A<sup>1</sup>, C<sup>1</sup>. (c) 1.41m.

**15.30** (a)  $348.16 \text{ ms}^{-1}$

(b) 336 m/s

(c) Resonance will be observed at 17cm length of air column, only intensity of sound heard may be greater due to more complete reflection of the sound waves at the mercury surface.

**15.31** From the relation,  $v = \frac{nv}{2L}$ , the result follows.

$$\mathbf{15.32} \quad t = \left[ \frac{6400 - 3500}{8} + \frac{2500}{5} + \frac{1000}{8} \right] \times 2$$

$$= 1975 \text{ s.}$$

$$= 32 \text{ minute } 55 \text{ second.}$$

$$\mathbf{15.33} \quad c = \sqrt{\frac{3P}{\rho}} = \sqrt{\frac{3RT}{M}}, v = \sqrt{\frac{\gamma P}{\rho}} = \sqrt{\frac{\gamma RT}{M}}$$

$$\frac{c}{v} = \sqrt{\frac{3}{\gamma}} \text{ and } \gamma = \frac{7}{5} \text{ for diatomic gases.}$$

**15.34** (a) (ii), (b) (iv), (c) (iii), (d) (i).

**15.35** (a) 5m, (b) 5m, (c) 50Hz, (d)  $250 \text{ ms}^{-1}$ , (e)  $500\pi \text{ ms}^{-1}$ .

**15.36** (a)  $6.4\pi$  radian, (b)  $0.8\pi$  radian, (c)  $\pi$  radian, (d)  $3\pi/2$  radian, (e)  $80\pi$  radian.